

## HP16 SERIES HEAT PUMP UNITS (211, 261, 311, 410, 460, 510 & 650)

### I - INTRODUCTION

HP16 series heat pump outdoor units consist of seven models ranging from 1-1/2 through 5 ton. The systems are expansion valve. Refrigerant line kits are available in various lengths and must be ordered extra. Refer to "Unit Information Section F" line kit table for proper selection.

All major components must be matched according to Lennox recommendations for the compressors to be covered under warranty. A misapplied system will cause erratic operation and can result in early compressor failure.

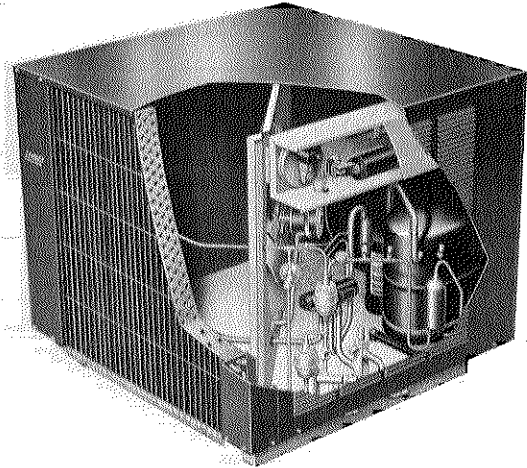

### II - UNIT INFORMATION

#### A - Specifications

Model No.		HP16-211V	HP16-261V	HP16-311V	HP16-411V HP16-413V	HP16-461V HP16-463V	HP16-511V HP16-513V	HP16-651V HP16-653V
Outdoor Coil	Net face area (sq. ft.)	6.67	6.67	8.00	10.11	10.11	12.9	12.9
	Tube diam. (in.)	3/8	3/8	3/8	3/8	3/8	3/8	3/8
	No. of rows	3	3	3	3	3	3	4
	Fins per inch	15	15	15	15	15	15	15
Outdoor Fan	Diameter (in.)	18	20	20	22	24	24	24
	No. of blades	4	4	4	4	4	4	4
	Motor hp	1/10	1/5	1/5	1/4	1/3	1/3	1/3
	Cfm (factory setting)	1750	2400	2900	3100	3800	3600	3800
	Rpm (factory setting)	1085	1115	1040	830	830	840	810
	Watts (factory setting)	135	205	305	285	395	370	425
Refrigerant-22 (charge furnished)		7 lbs. 14 oz.	8 lbs. 7 oz.	9 lbs. 4 oz.	11 lbs. 0 oz.	12 lbs. 4 oz.	14 lbs. 4 oz.	19 lbs. 8 oz.
Liquid line connection (sweat)		3/8	3/8	3/8	3/8	3/8	3/8	1/2
Vapor line connection (sweat)		5/8	5/8	3/4	3/4	7/8	7/8	1 1/8
Shipping weight (lbs.)		245	250	275	322	333	403	411
Number of packages		1	1	1	1	1	1	1

#### B - Electrical Data

Model Number		HP16-211V	HP16-261V	HP16-311V	HP16-411V	HP16-413V
Line voltage data		208/230V 60hz/1ph.	208/230V 60hz/1ph.	208/230V 60hz/1ph.	208/230V 60hz/1ph.	208/230V 60hz/3ph
Compressor	Rated load amps	9.7	11.5	14.7	17.9	22.5
	Power factor	.95	.96	.95	.94	.89
	Locked rotor amps	48.0	54.0	65.0	83.5	66.0
Outdoor Coil	Full load amps	0.70	1.3	1.5	2.0	2.0
Fan Motor	Locked rotor amps	1.0	3.5	3.5	4.0	4.0
Recommended maximum fuse size (amps)		20	25	30	40	30
*Minimum circuit ampacity		12.8	15.7	19.8	24.4	17.6

\*Refer to National Electrical Code manual to determine wire, fuse and disconnect size requirements.  
NOTE - Extremes of operating range are plus 10% and minus 5% of line voltage.

## B - Electrical Data

Model Number		HP16-461V	HP16-463V	HP16-511V	HP16-513V	HP16-651V	HP16-653V
Line voltage data		208/230V 60hz/1ph.	208/230V 60hz/3ph	208/230V 60hz/1ph	208/230V 60hz/3ph	208/230V 60hz/1ph	208/230V 60hz/3ph
Compressor	Rated load amps	21.5	13.7	25.6	15.9	28.0	19.0
	Power factor	.96	.88	.96	.90	.97	.90
	Locked rotor amps	95.4	82.0	116.0	92.0	142.0	107.0
Outdoor Coil	Full load amps	2.5	2.5	2.5	2.5	2.5	2.5
Fan Motor	Locked rotor amps	5.5	5.5	5.5	5.5	5.5	5.5
Recommended maximum fuse size (amps)		50	30	60	35	60	45
*Minimum circuit ampacity		29.4	19.6	34.5	22.4	37.5	26.3

\*Refer to National Electrical Code manual to determine wire, fuse and disconnect size requirements.  
NOTE - Extremes of operating range are plus 10% and minus 5% of line voltage.

## C - Unit Dimensions

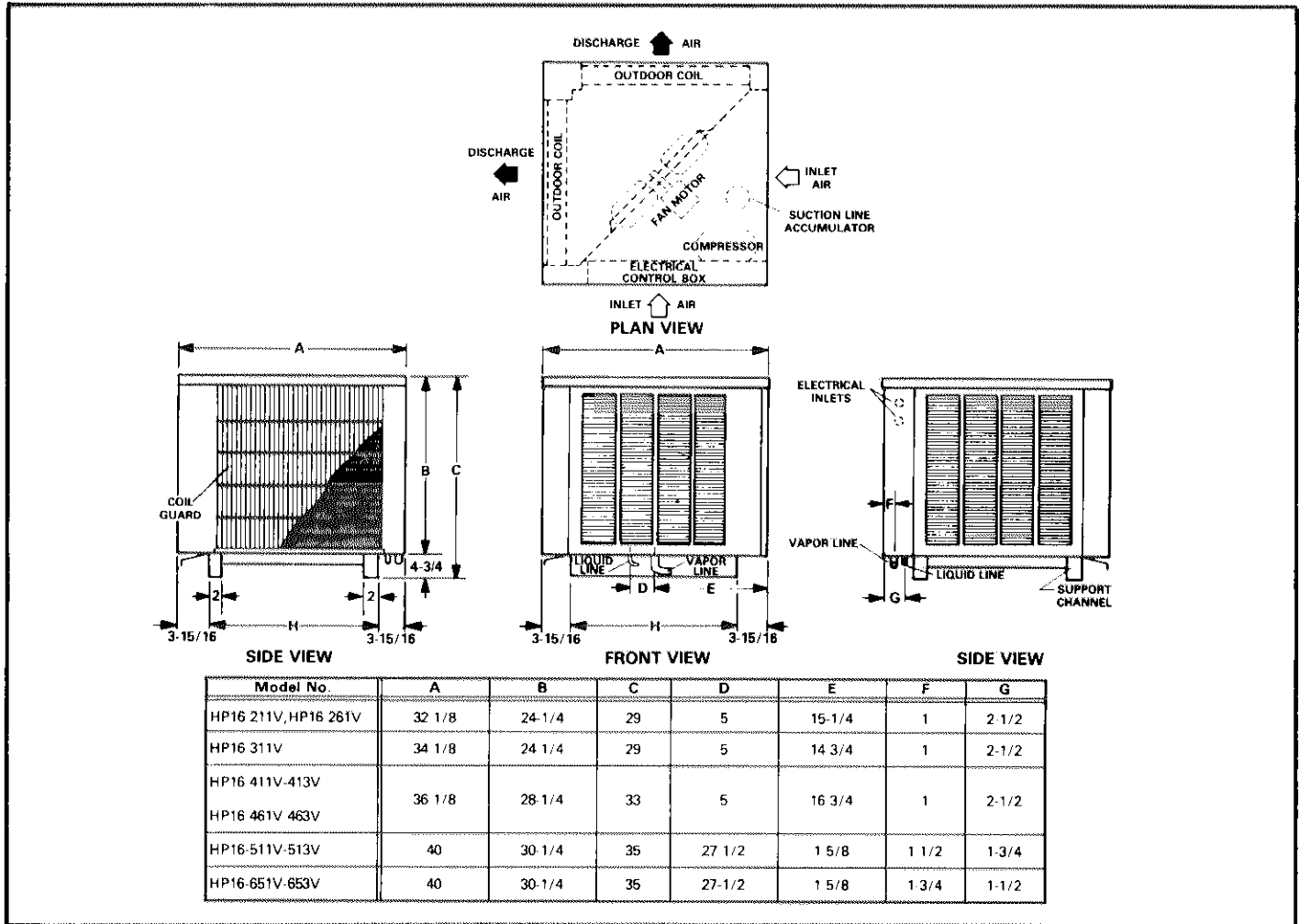

## D - Pressure Curves

It is very critical to avoid overcharging a heat pump system. It is recommended to charge the system in the cooling cycle if weather conditions permit. If the unit must be charged in the heating cycle, the charge must be re-checked in the cooling cycle as soon as outdoor conditions permit.

Each unit is furnished with a normal operating pressure curve. The curve uses suction pressure, discharge pressure and outdoor

temperature comparison. To use the chart, first check suction pressure, then move over to the outdoor temperature and finally down to the discharge pressure. If the discharge pressure is within five pounds of this reading, the unit is properly charged, providing the three conditions meet in the unshaded area of the chart. If they meet in the shaded area, there is something wrong with the system and further checks are needed.

# D - Pressure Curves

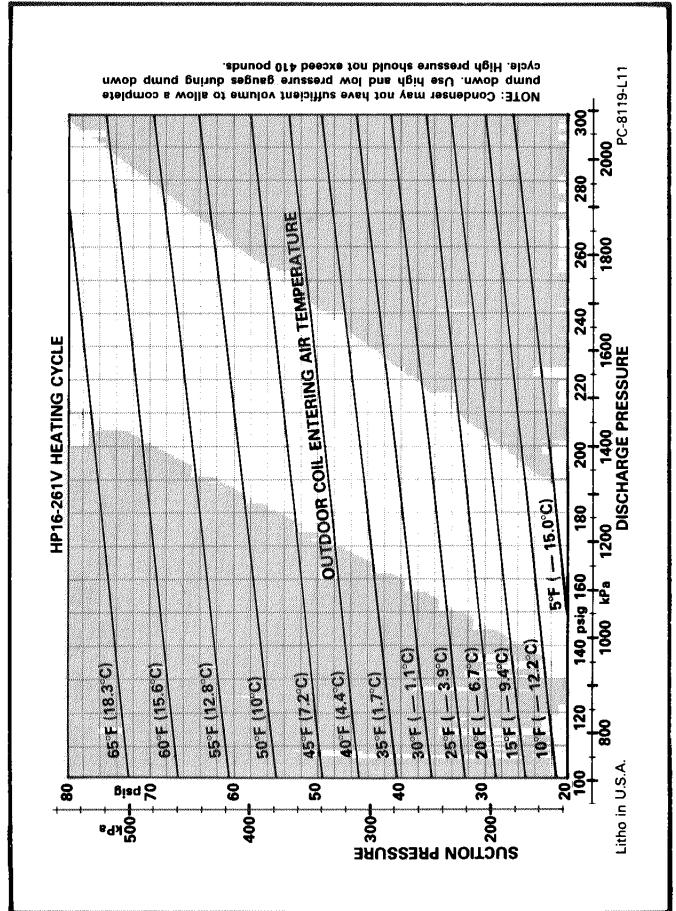
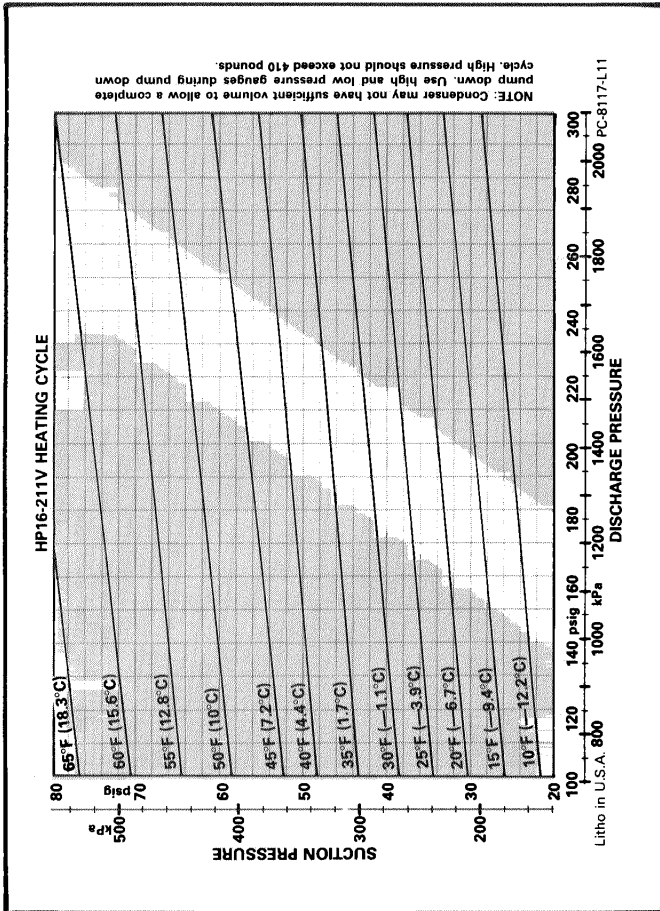
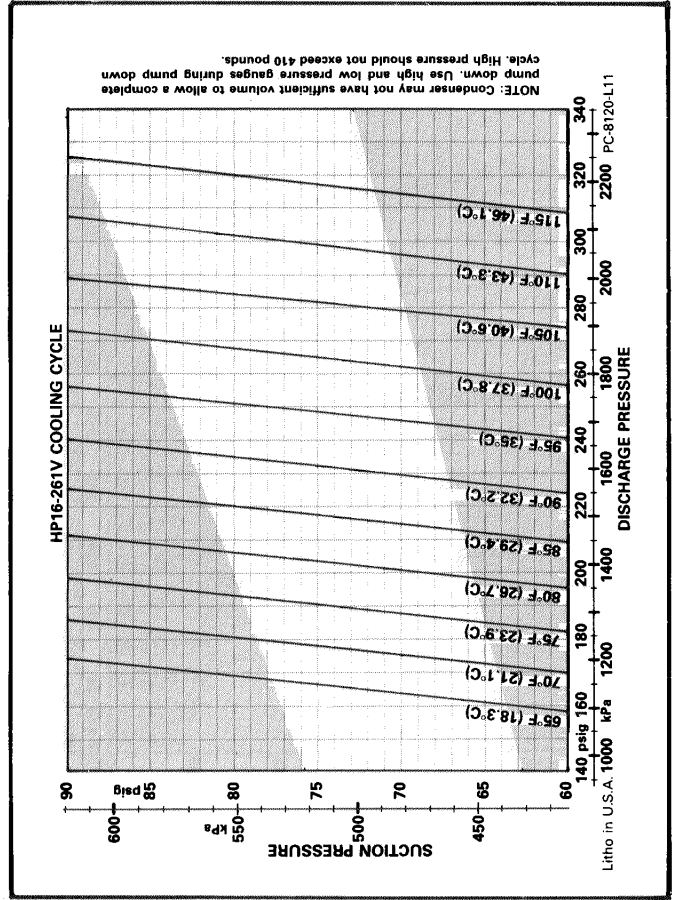
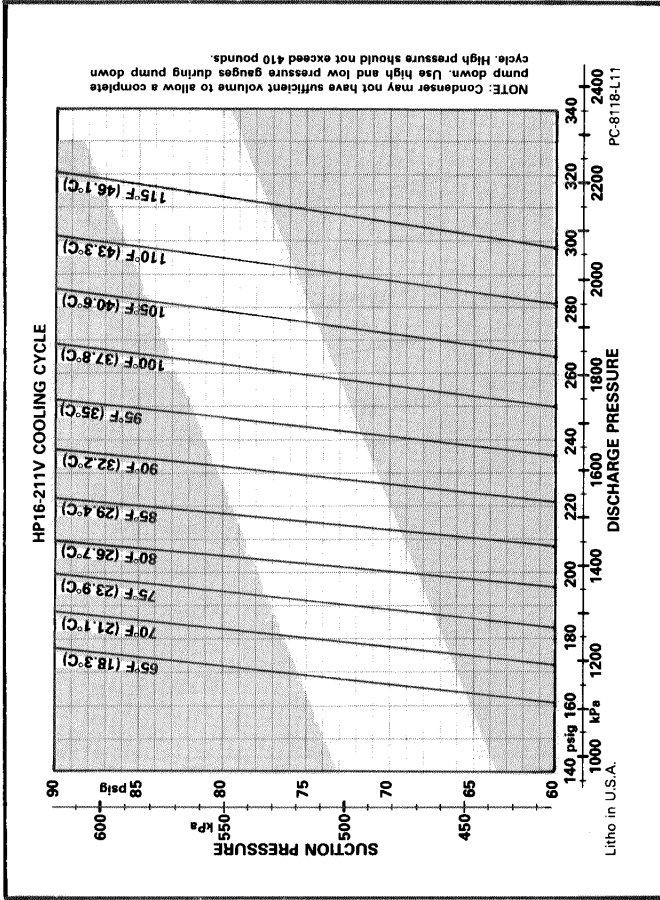

# D - Pressure Curves

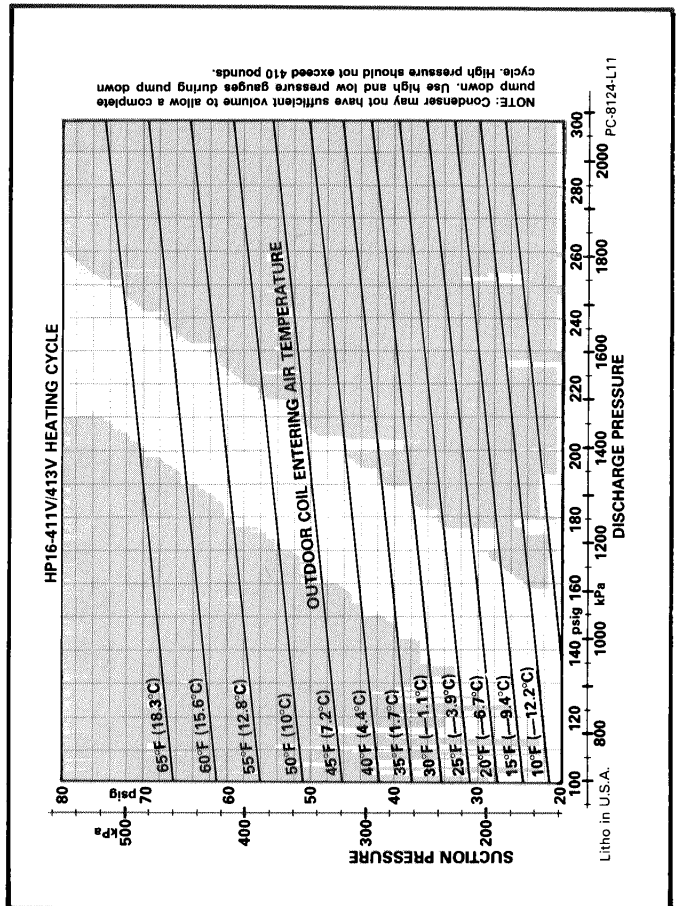
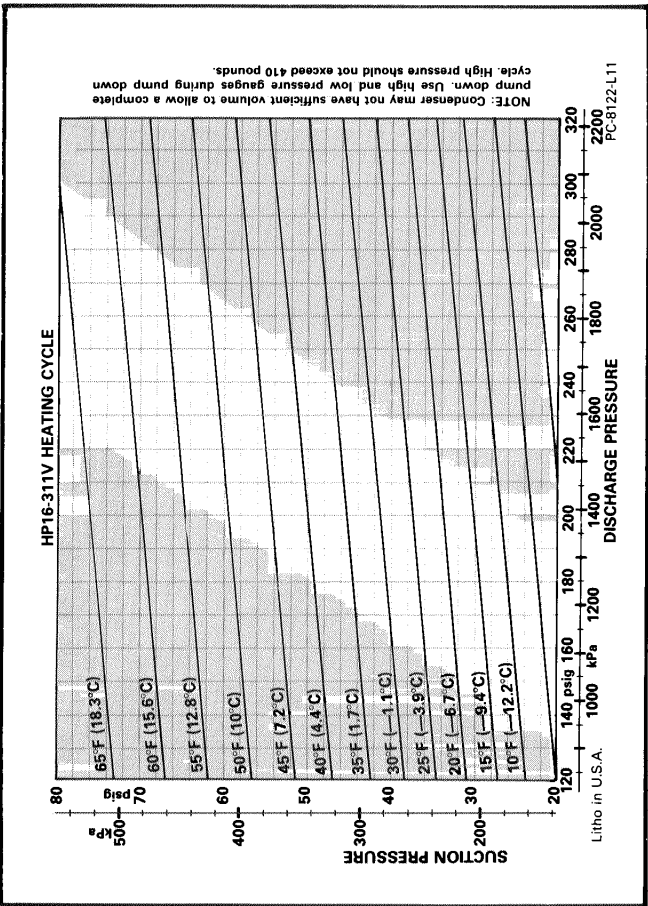
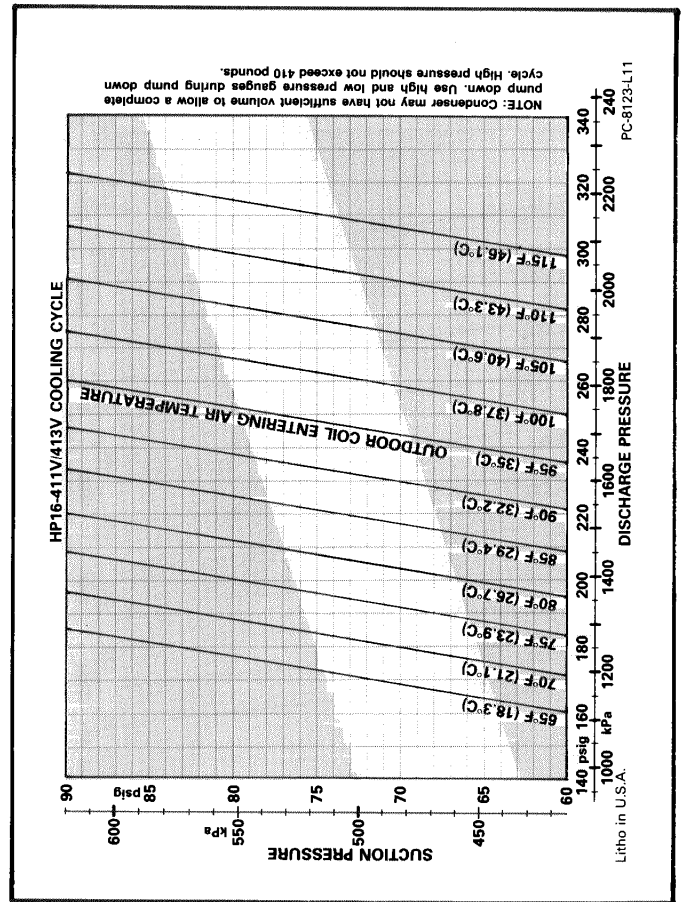
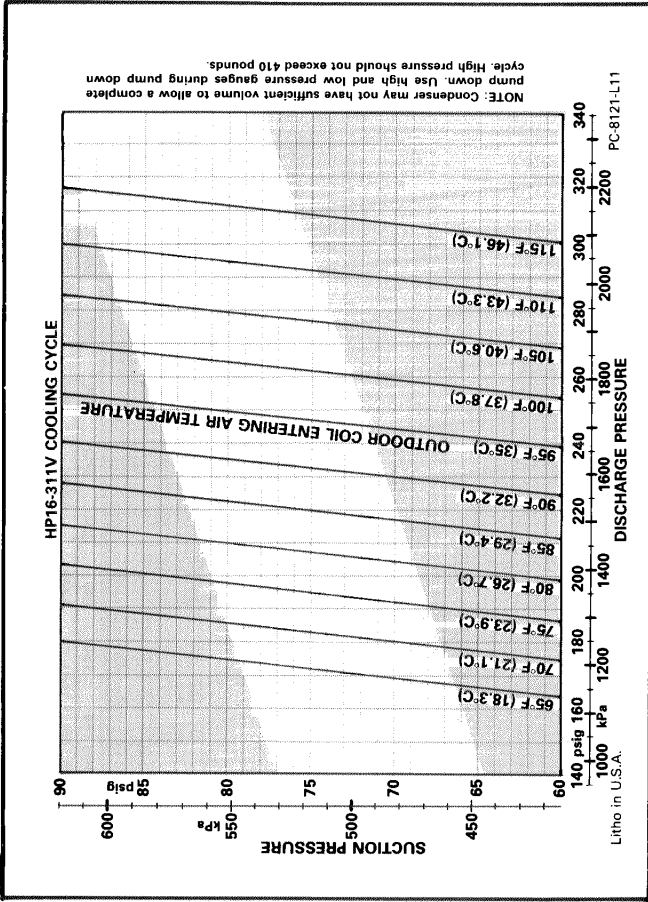

# D - Pressure Curves

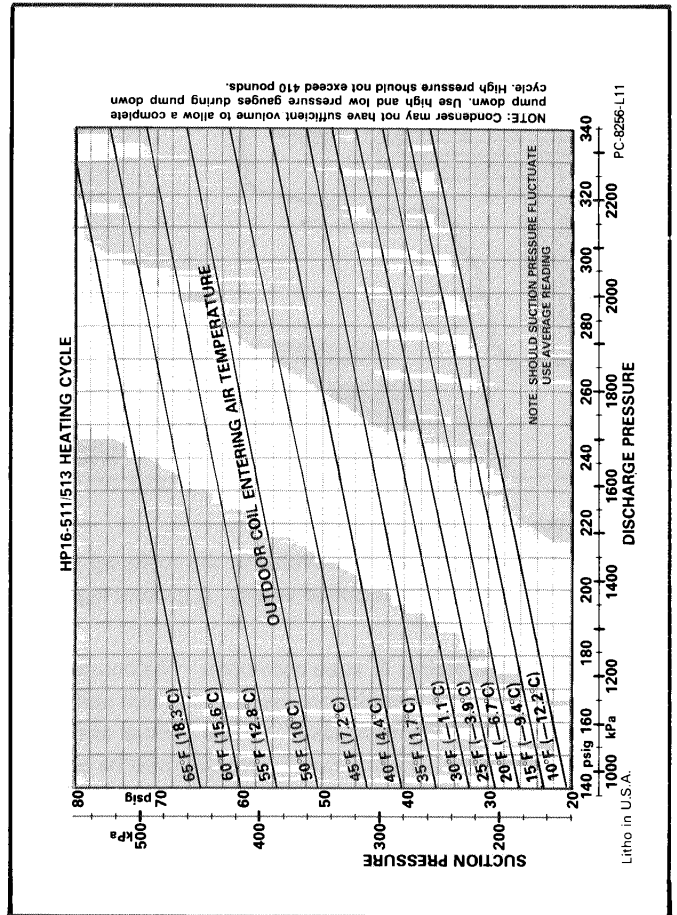
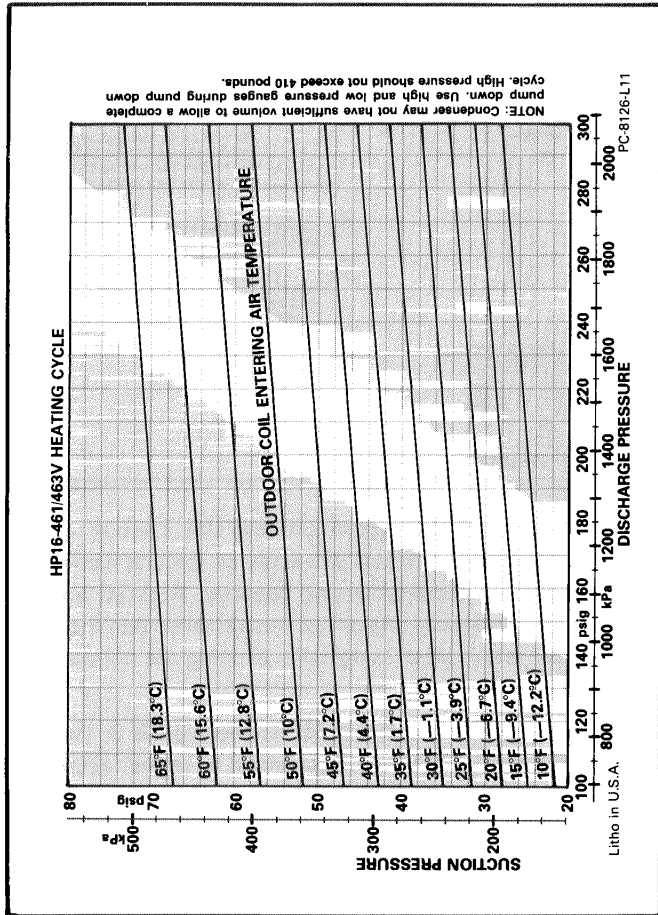
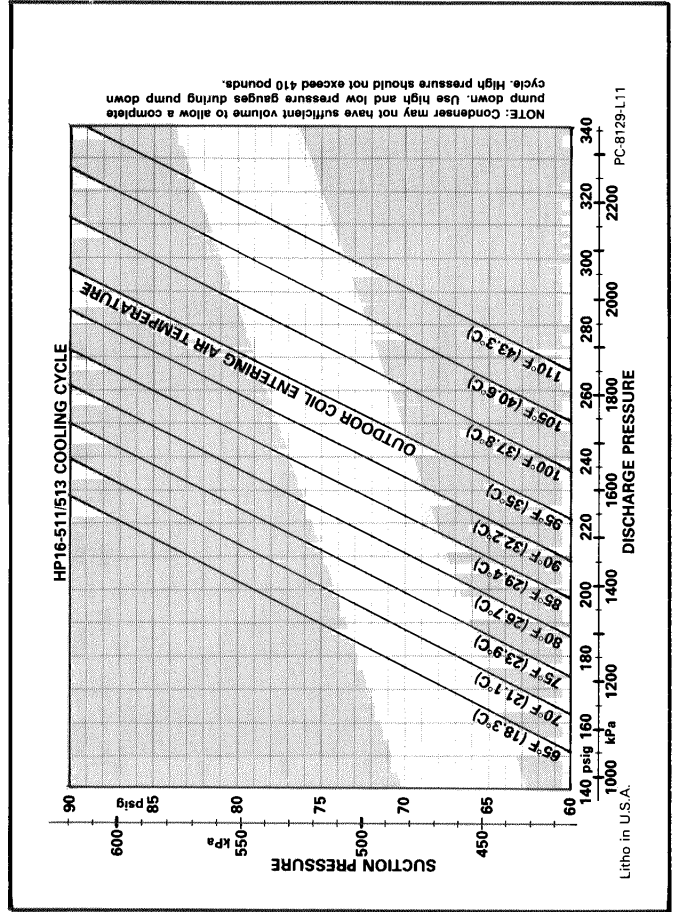
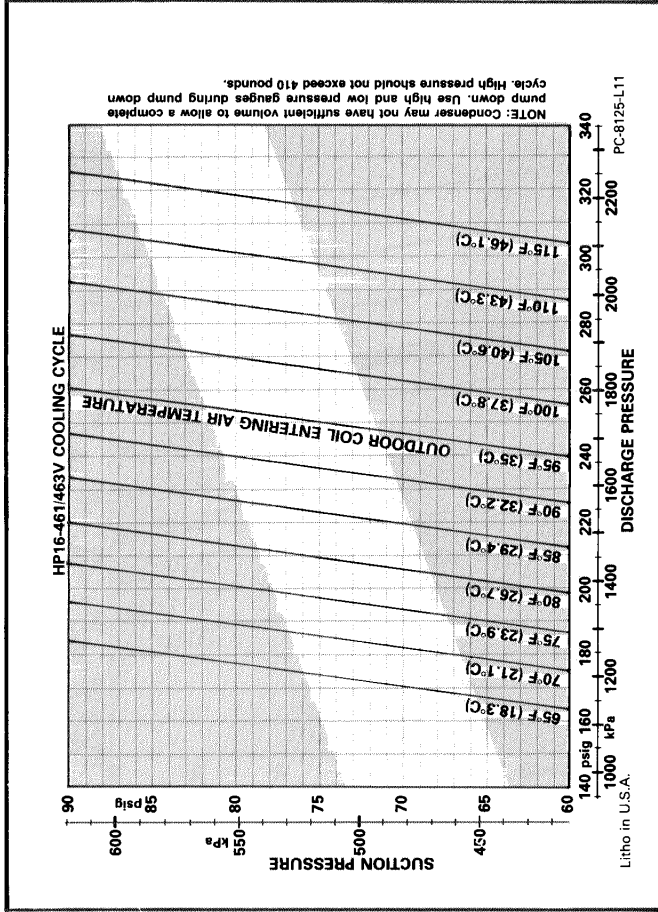

## D - Pressure Curves

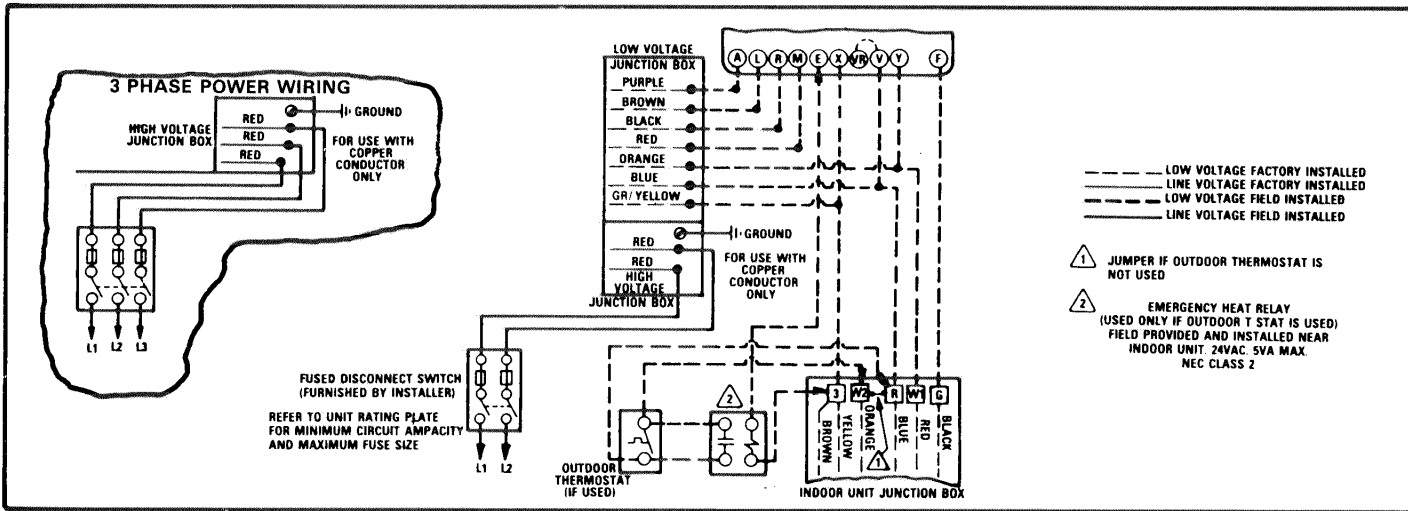
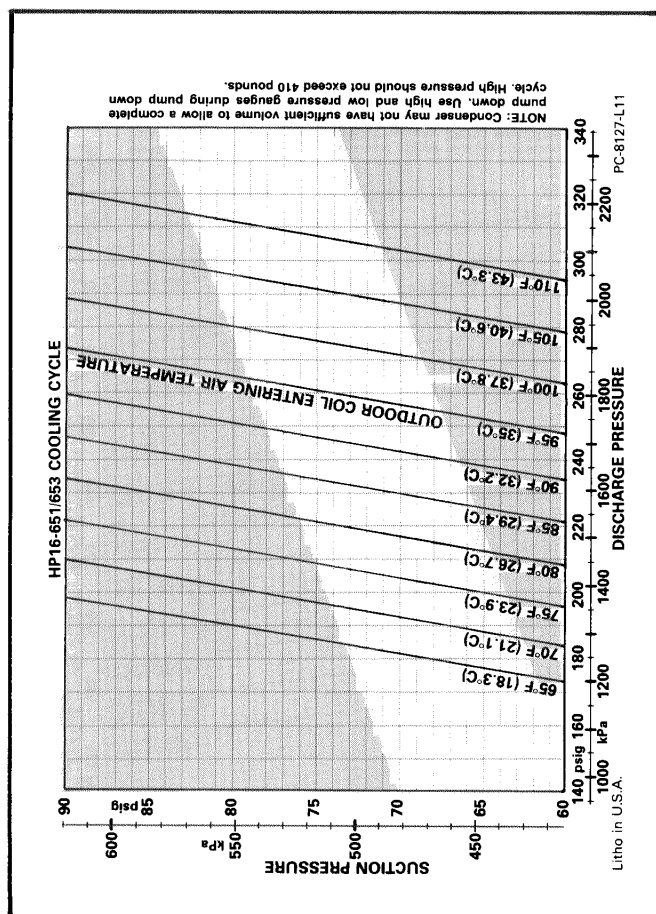
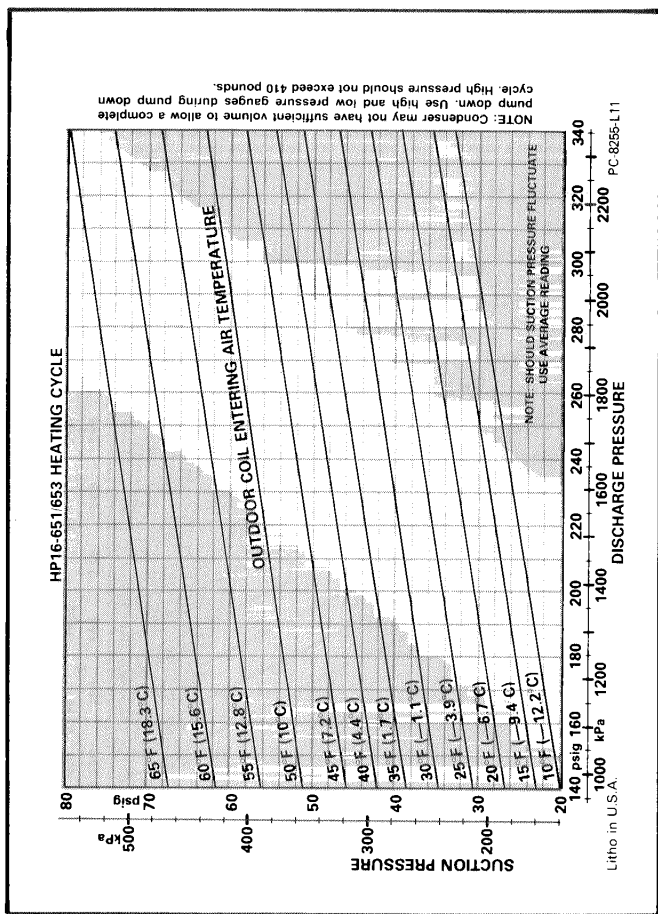

FIGURE 1

## E - Field Wiring (Figure 1)

High voltage pigtail leads are provided in the make-up area of control box for connection to power supply. A ground lug is also provided.

**Note on unit wire sizing & fuse selection** - Minimum circuit ampacity and maximum fuse size are listed on the unit nameplate (also on pages 1 & 2 "Electrical Data" of this manual and in the Engineering Handbook). The unit supply wire size must be obtained from the appropriate Table 310 of the National Electric Code. Sometimes nuisance tripouts occur to circuit breakers that may be in the branch circuit. This condition is usually encountered when the circuit breaker is sized to the equipments minimum circuit am-

capacity (MCA) instead of the maximum fuse size. Lennox recommends using the maximum fuse size listed on the unit nameplate to assure maximum current-carrying capacity. A circuit breaker size from MCA is normally one or two sizes smaller than the maximum fuse size and is often marginal in carrying the normal starting current.

**Low voltage** connections are made at the pigtails in the low voltage junction box. The thermostat must have the factory installed jumper between "V" and "VR" in place; all heating and cooling thermostat functions are operated from the indoor unit transformer; unlike earlier Lennox "two transformer" heat pump systems that required circuit isolation at the thermostat.

## F - Approved Matchups

The HP16 is for use with single circuit coils with expansion check valve systems only.

All major components (indoor blower/coils) must be matched according to Lennox recommendations for the compressor to be covered under warranty. Refer to the Engineering Handbook for approved system matchups. A misapplied system will cause erratic operation and can result in early compressor failure.

Refrigerant line sets are available for the HP16 series units. Line sets for the HP16-650V are field fabricated. Lines are furnished with a flare fitting for connection to matching indoor coil and stubbed on opposite end for sweat connection to outdoor unit. Table 1 gives the line set model numbers and line sizes.

LINE SETS TABLE 1

Outdoor Unit Model No.	Line Set Model No.	Length of Lines (ft.)	Liquid Line (o.d. in.)	Vapor Line (o.d. in.)
HP16-211V HP16-261V	L10-26-20	20	3/8	5/8
	L10-26-25	25		
	L10-26-35	35		
	L10-26-50	50		
HP16-311V HP16-410V	L10-41-20	20	3/8	3/4
	L10-41-30	30		
	L10-41-40	40		
HP16-460V HP16-510V	L10-65-30	30	3/8	7/8
	L10-65-40	40		
	L10-65-50	50		
HP16-650V	Field Fabricate	---	1/2	1-1/8

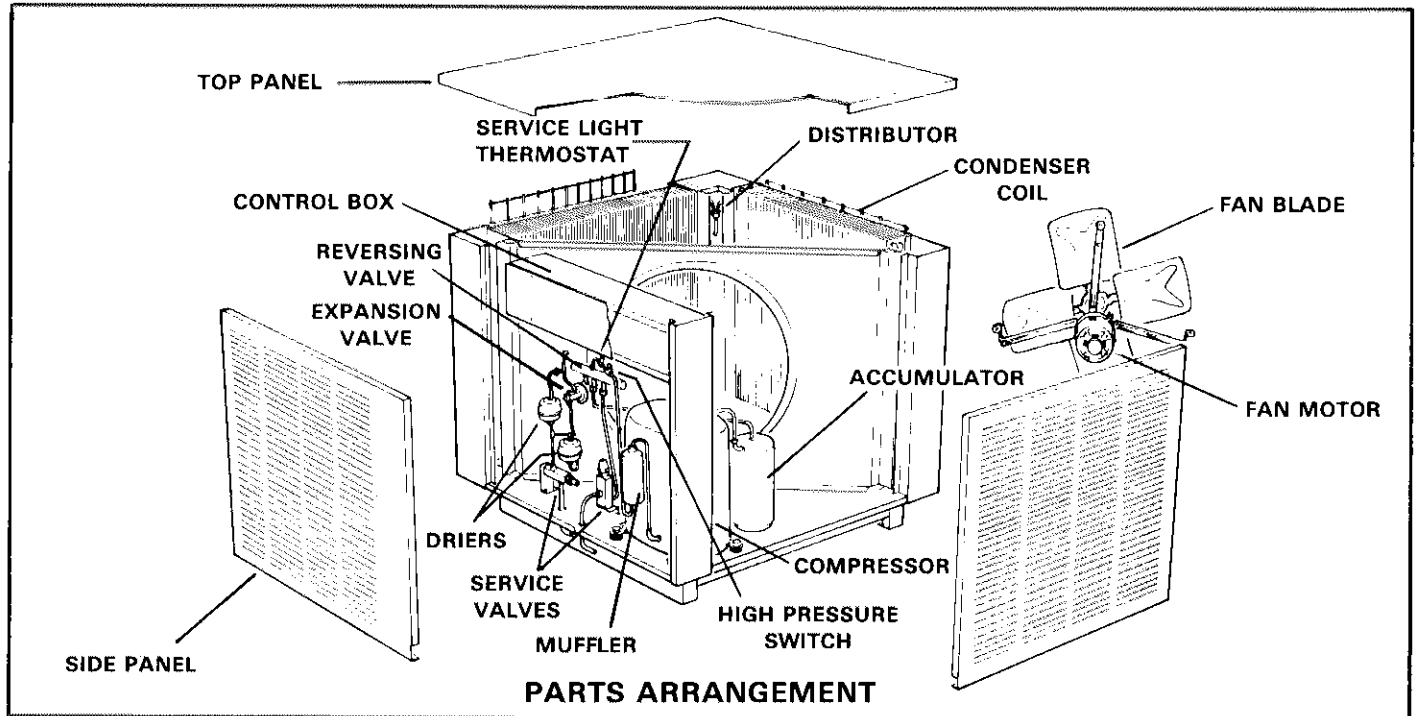

FIGURE 2

## III - COMPONENTS

Figure 2 shows a parts arrangement with components identified.

### A - Control Box (Figure 3)

#### 1 - Start Controls (Single Phase Units Only)

Single phase units contain a potential relay used to disconnect the start capacitor from the circuit when the compressor reaches operating speed.

#### 2 - Compressor Contactor

Powers the compressor and condenser fan (through the defrost control) on demand.

#### 3 - Defrost Control Relay

Energized by the defrost control pressure switch, the D.P.D.T. (2 pole-double throw) defrost relay energizes the reversing valve and first stage electric heat.

#### 4 - Defrost Control

Refer to Page 9, Section E.

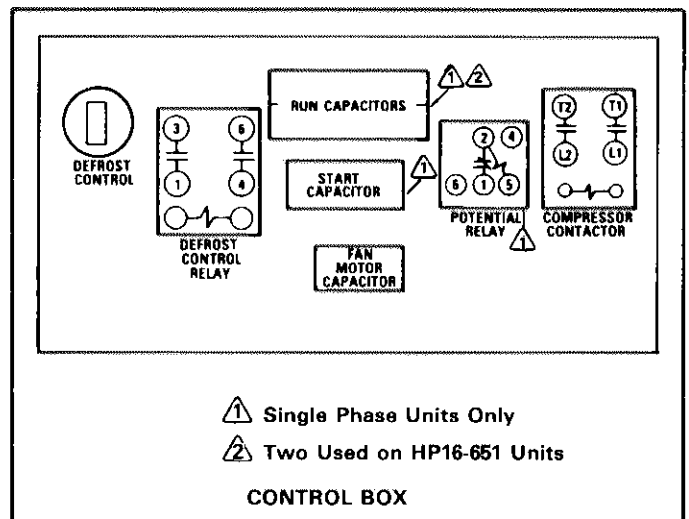

- △ Single Phase Units Only
- △ Two Used on HP16-651 Units

CONTROL BOX

FIGURE 3

## 5 - Compressor Capacitors (Single Phase Units Only)

The start and run capacitors are matched specifically for each single phase compressor motor. During starting, the start and run capacitors are in parallel for increased capacitance.

Values are as follows:

### 211 Units

**Start** -135mfd - 155 mfd (320VAC)

**Run** - 25mfd (370VAC)

Parallel Capacitance - 160 mfd - 180 mfd (320VAC)

### 261 Units

**Start** - 135mfd - 155mfd (320VAC)

**Run** - 30mfd (370VAC)

Parallel Capacitance -165 mfd - 185 mfd (320VAC)

### 311 Units

**Start** - 135mfd - 155mfd (320VAC)

**Run** - 35mfd (370VAC)

Parallel Capacitance -170 mfd - 190 mfd (320VAC)

### 411 Units

**Start** - 135mfd - 155mfd (320VAC)

**Run** - 40mfd (370VAC)

Parallel Capacitance -175 mfd - 195 mfd (320VAC)

### 461,511 Units

**Start** -135 mfd - 155 mfd (320 VAC)

**Run** - 40 mfd (370VAC)

Parallel Capacitance -175 mfd - 195 mfd (320 VAC)

### 651 Units

**Start** -135 mfd - 155 mfd (320 VAC)

**Run** - 30 mfd (440VAC)

Parallel Capacitance -165 mfd - 185 mfd (320 VAC)

## 6 - Fan/Motor Capacitor

The outdoor fan motor capacitance values are as follows:

211,261,311 5 mfd, 370 VAC

410 & 460 7mfd, 370VAC

510 & 650

## B - Compressor Compartment

### 1 - Compressor

HP16 211,261,311,411 & 463 units use Copeland compressors. 511 & 513 units use Tecumseh compressors; 651 & 653 units use Lennox compressors. Copeland and Tecumseh compressors are pro-

ected by an internal pressure relief valve. This valve opens at a discharge and suction differential of 450 psig.  $\pm$  50. All compressors are equipped with an internal line break overload. The Lennox compressors do not have internal pressure relief valves.

### Oil charge

#### HP16 211,261,

311,411,461,463 55 ounces mineral oil (Viscosity 190-210)

#### 511 & 513

54 ounces mineral oil (Viscosity 190-210)

#### 651 & 653

65 ounces — 25% Zerol 150 Re:SP6108  
75% Capella D or Suniso 4G5

### 2 - Crankcase Heaters

A self regulating well mounted crankcase heater is provided on all HP16 series units. Heaters are typically 40 watts at 230 VAC.

### 3 - Crankcase Thermostat

The crankcase thermostat is located on the lower half of the compressor. It senses the temperature of the compressor crankcase. It opens at 190°F  $\pm$  5°F on temperature rise and de-energizes the compressor controls to stop the compressor protecting it from excessive temperatures. It automatically resets at 110°F  $\pm$  7°F.

### 4 - High Pressure Switch

Switch is mounted in the discharge line downstream of the discharge muffler. It opens at 410 psig de-energizing the compressor controls to stop the compressor protecting it from excessive pressure. It must be manually reset and will manually reset only after the system pressure drops below 180 psig.

### 5 - Service Light Thermostat

Thermostat is mounted on the discharge line upstream of the discharge muffler. It is used in conjunction with the room thermostat. It monitors discharge temperature and closes on a temperature fall (closes at 110°F  $\pm$  5°F, opens at 130°F  $\pm$  5°F). If the room thermostat is in a heating demand mode with second stage H2 bulb made and the service light thermostat closed, a red "service light" comes on at the room thermostat; this indicates the compressor is not operating with demand. The "service light" may come on briefly during compressor startup until the service light thermostat opens, this is normal.

### 6 - Ambient Thermistor

The ambient compensating thermistor is located on the fan orifice panel behind left corner of control box. It is used in conjunction with a resistor in the room thermostat to provide constant heat anticipation from lower to higher cycle per hour rates as the outdoor temperature falls. It is a NTC thermistor (negative temperature coefficient — increase in temperature equals decrease in resistance). Resistance at 77°F = 260 ohms  $\pm$  10%; at 100°F = 150 ohms, at 32°F = 861 ohms.

## C - Outdoor Coil Compartment

The high pressure monitor portion of the defrost control is located between the outdoor coil and outdoor fan. The outdoor coils are circuited with refrigerant flow from bottom to top during a defrost cycle. This provides more positive defrost and better condensate run-off.



The outdoor coils are blow-through with horizontal discharge. The fan motor is in the compressor compartment. The fan pulls air through the compressor compartment and blows through the outdoor coils.

The fan motor is prelubricated for an extended period of operation. Check motor for lubrication requirements. For fan service access remove top of unit and remove bolts securing fan assembly. Figure 4 illustrates the condenser fan and motor assembly for blade position in the orifice panel.

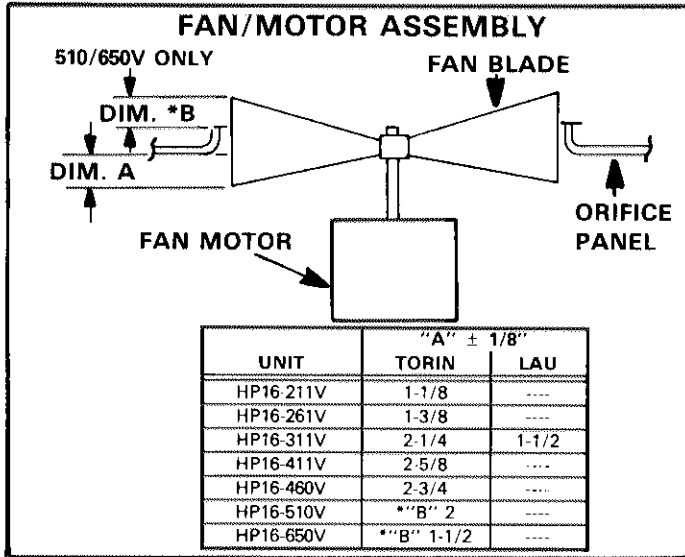

FIGURE 4

### D - Room Thermostat

The HP16 uses a single stage cool, two stage heat thermostat with ambient compensation and emergency heat subbase. The ambient compensation feature works with the heat anticipator to improve anticipation characteristics over the operating range of the system.

Thermostat is equipped with two indicator lights. The red service light warns the homeowner that the compressor is not operating properly and the heat pump is in need of service. As the HP16 is cycled "on" by a heating demand, this light may come on briefly until the compressor reaches its normal operating conditions. The homeowner should be made aware that this short intermittent lighting is normal.

The amber light comes on whenever the thermostat is placed into emergency heat. It reminds the homeowner that he or she is not getting the benefit of the heat pump and is using only expensive electric heat.

### E - Defrost Control (Figure 5)

Robertshaw defrost control is pressure initiated and temperature terminated. The high pressure monitor portion of the defrost control is located between the outdoor coil and the orifice panel. Low pressure is monitored from the control box. The temperature sensor bulb is clamped to the liquid line in the compressor compartment.

The control will initiate the defrost cycle at a pressure difference across the outdoor coil at approximately  $0.27'' \pm 0.03''$  WC. The defrost cycle will terminate when the temperature sensor reaches  $65^{\circ}\text{F} \pm 5^{\circ}\text{F}$ .

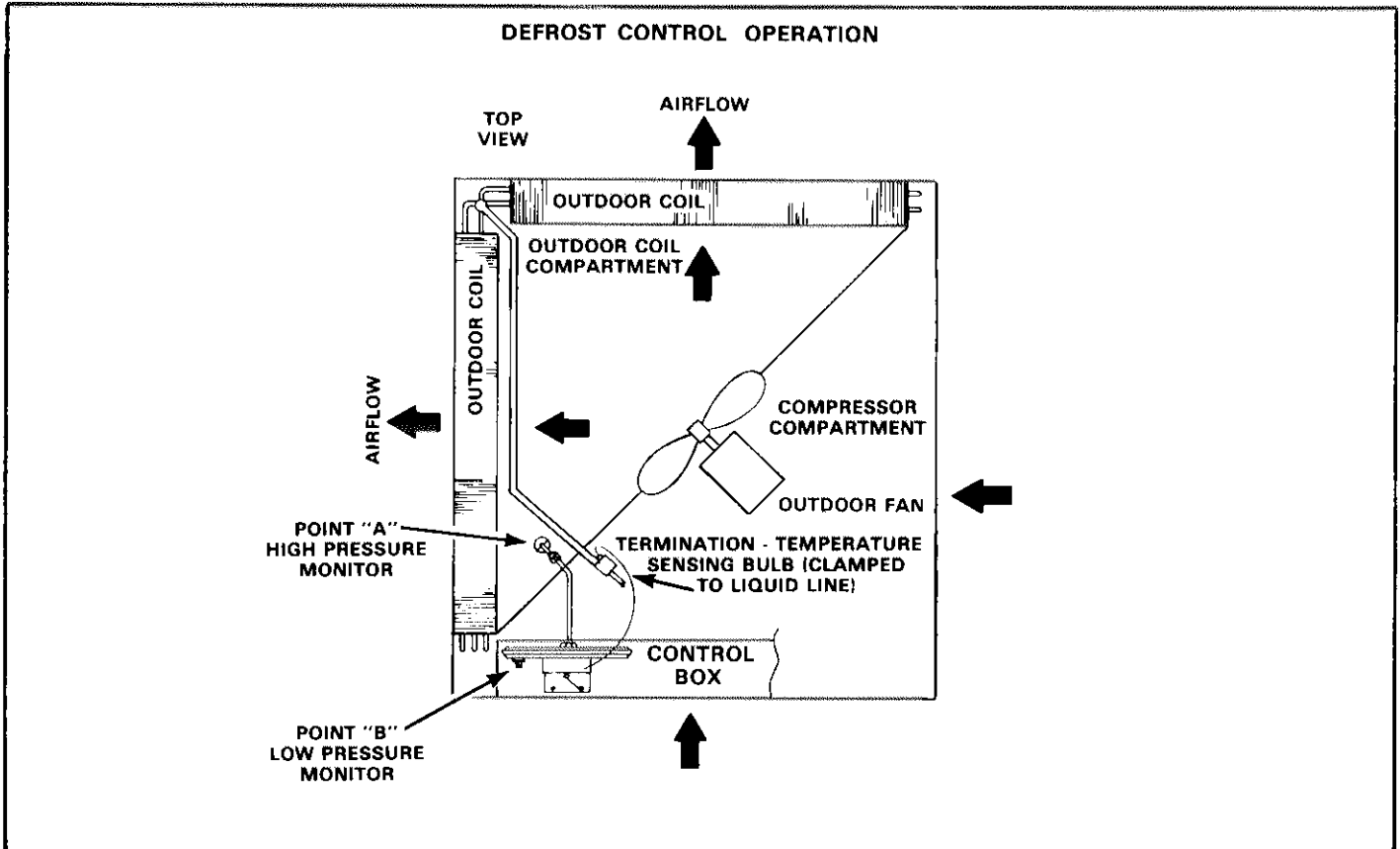

FIGURE 5

## IV - REFRIGERANT SYSTEM

All units in the HP16 series have stubbed liquid and vapor lines for sweat connections to the line set feeding the indoor coil. Each unit also has liquid and vapor line service valves inside the unit cabinet. Standard heat pump refrigeration circuitry is used with inverse outdoor coil circuiting. The inverse circuiting allows for refrigerant flow from bottom to top of outdoor coils in the defrost mode providing positive defrost and better condensate run-off.

### A - Manifold Connections (Figures 6 & 7)

Separate discharge and suction services ports are provided at the compressor for connection of gauge manifold during charging pro-

cedures. Figures 6 and 7 show the gauge manifold connections to the service ports and refrigerant flow in the cooling and heating cycles.

### B - Driers

High capacity two drier (with internal check valve) system is utilized in both the cooling and heating cycle. Driers are mounted in parallel flow arrangement in the liquid line of the system. Internal check valve assures correct refrigerant flow. Driers use 3/8" sweat connections and have a working pressure of 500 psig., burst pressure 2500 psig. If replacement is necessary, order another of like design and capacity, see Repair Parts Microfiche.

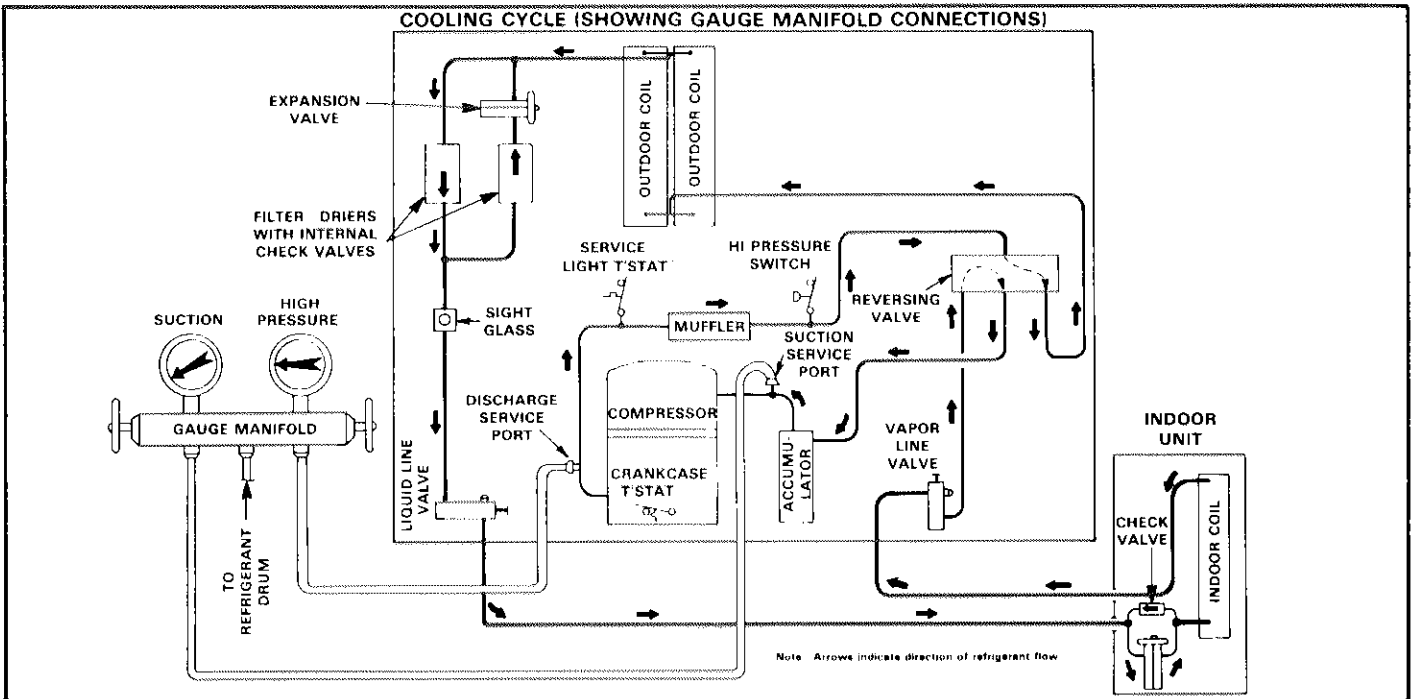

FIGURE 6

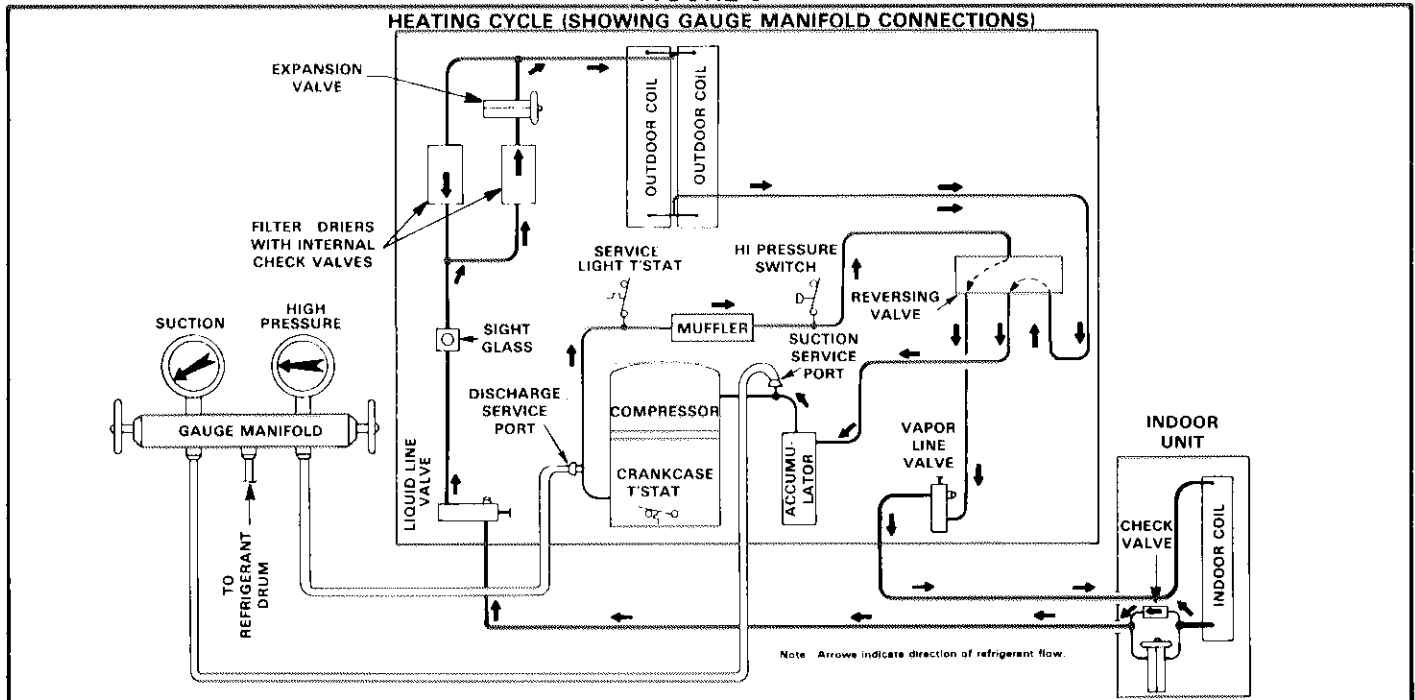

FIGURE 7

# V - SCHEMATIC WIRING DIAGRAM OPERATING SEQUENCE

## A - Cooling & Heating Cycle Sequence

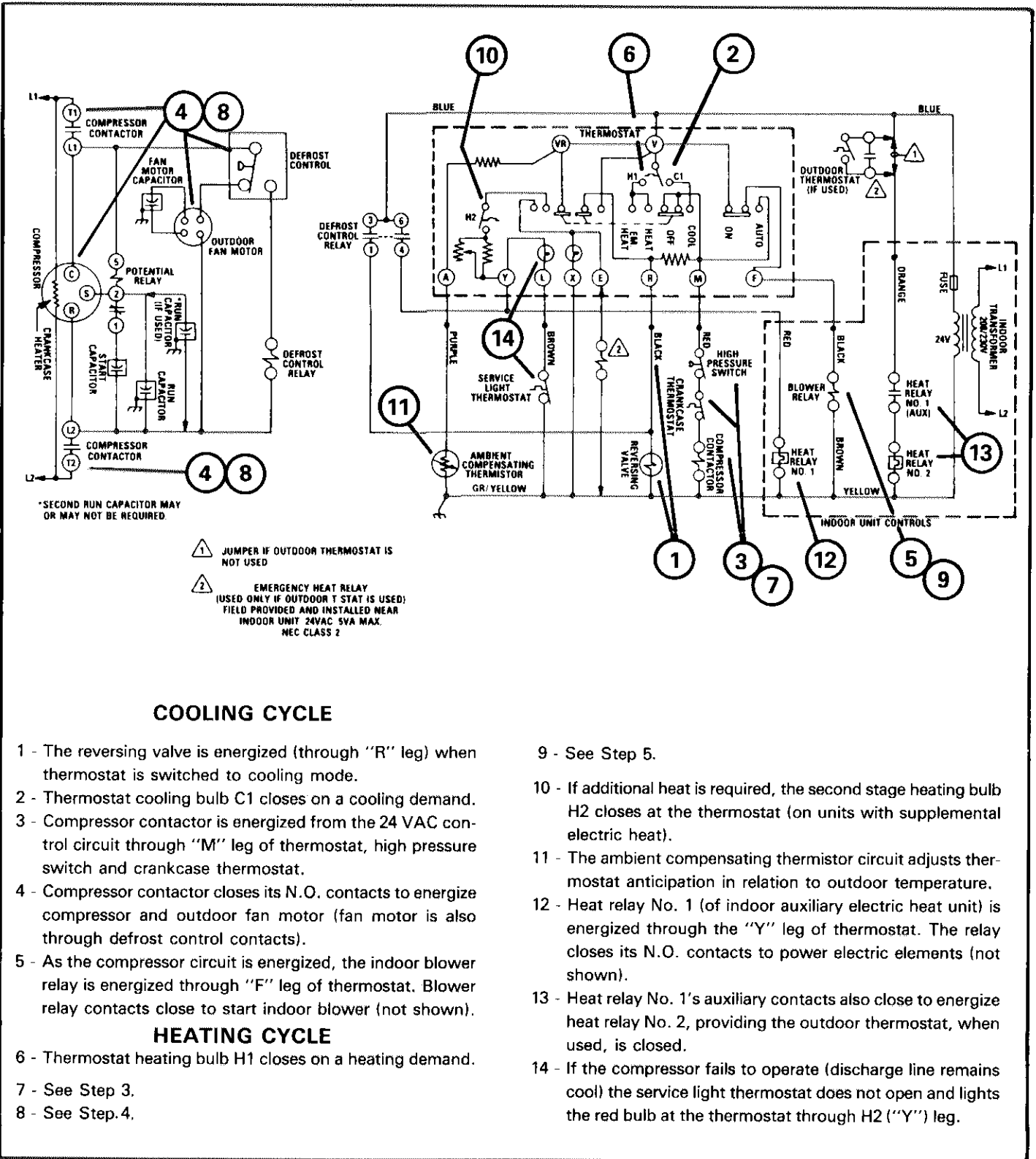

FIGURE 8

## B - Defrost & Emergency Heat Sequence

