

HP21 SERIES UNITS INCLUDING TSC-2, TSC-3 AND TSC-6

The HP21 is a high efficiency residential split-system heat pump with a two-speed compressor. **Early** models include HP21-411, -511 and -651. **Late** models built after March 1, 2000 include HP21-36, -48 and -60. All models are available in sizes ranging from 3 through 5 tons in either single or three-phase configuration. Early and late models feature solid-state two-speed control and new solid-state demand defrost control. The two-speed control regulates compressor speed in response to thermostat demand during cooling mode. Compressor speed is regulated by outdoor air temperature during heating mode. The defrost control monitors outdoor air temperature and liquid line temperature to determine when defrost is needed. The series uses conventional heat pump circuitry with expansion valves in the outdoor and indoor units.

This manual is divided into sections which discuss the components, refrigerant system, charging procedures, maintenance and operation sequences. All specifications in this manual are subject to change.



⚠ DANGER

Electric Shock Hazard.
May cause injury or death.

Line voltage is present at all components when unit is not in operation on units with single pole contactors.

Disconnect all remote electrical power supplies before opening unit panel.

Unit may have multiple power supplies.

⚠ WARNING

Improper installation, adjustment, alteration, service or maintenance can cause property damage, personal injury or loss of life. Installation and service must be performed by a qualified installer or service agency.

⚠ WARNING

Refrigerant can be harmful if it is inhaled. Refrigerant must be used and recovered responsibly.

Failure to follow this warning may result in personal injury or death.

TABLE OF CONTENTS

General	1
Specifications / Electrical	2
I Application	3
II Unit Components	3
TSC-2 Control	6
TSC-3 Control	10
TSC-6 Control	11
III Refrigerant System	20
IV Charging	23
V Maintenance	25
VI Miscellaneous	26
VII Wiring Diagrams and Operating Sequence	27

SPECIFICATIONS

Model No.		HP21-411	HP21-36-230	HP21-511	HP21-48-230	HP21-651	HP21-60-230
		HP21-413	HP21-36-233	HP21-513	HP21-48-233	HP21-653	HP21-60-233
Outdoor Coil	Face area (sq.ft.)	18.22/		21.64/		23.92/	
	outside / inside	17.53		20.81		23.01	
	Tube diameter (in.)	3/8		3/8		3/8	
	No. of Rows	2		2		2	
	Fins per inch	18		18		20	
Outdoor Fan	Diameter (in.)	24		24		24	
	No. of Blades	3		3		4	
	Motor hp	1/10		1/6		1/4	
	Cfm	3120		3200		4200	
	Rpm	820		815		815	
	Watts	155		200		310	
Refrigerant-22 (charge furnished)		13lbs. 10oz.		15lbs. 5oz.		18lbs. 10oz.	
Liquid line connection (sweat)		3/8		3/8		3/8	
Vapor line connection (sweat)		3/4		7/8		1-1/8	

ELECTRICAL DATA

Model No.		HP21-411	HP21-413	HP21-511	HP21-513	HP21-651	HP21-653
		HP21-36-230	HP21-36-233	HP21-48-230	HP21-48-233	HP21-60-230	HP21-60-233
Line voltage data - 60hz.		208/230/1ph	208/230/3ph	208/230/1ph	208/230/3ph	208/230/1ph	208/230/3ph
Compressor	Rated load amps	17.6	12.7	17.6	12.7	30.8	19.9
	Power factor	.98	.90	.98	.90	.92	.90
	Locked rotor amps	90.0	60.0	90.0	60.0	141.0	91.0
Outdoor Coil	Full load amps	0.7	0.7	1.0	1.0	1.7	1.7
Fan Motor	Locked rotor amps	1.2	1.2	1.9	1.9	2.9	2.9
Max fuse or circuit breaker size (amps)		40	25	40	25	60	45
*Minimum circuit ampacity		22.7	16.6	23.0	16.9	40.2	27.0

*Refer to National Electrical Code Manual to determine wire, fuse and disconnect size requirements.

NOTE - Extremes of operating range are plus 10% and minus 5% of line voltage

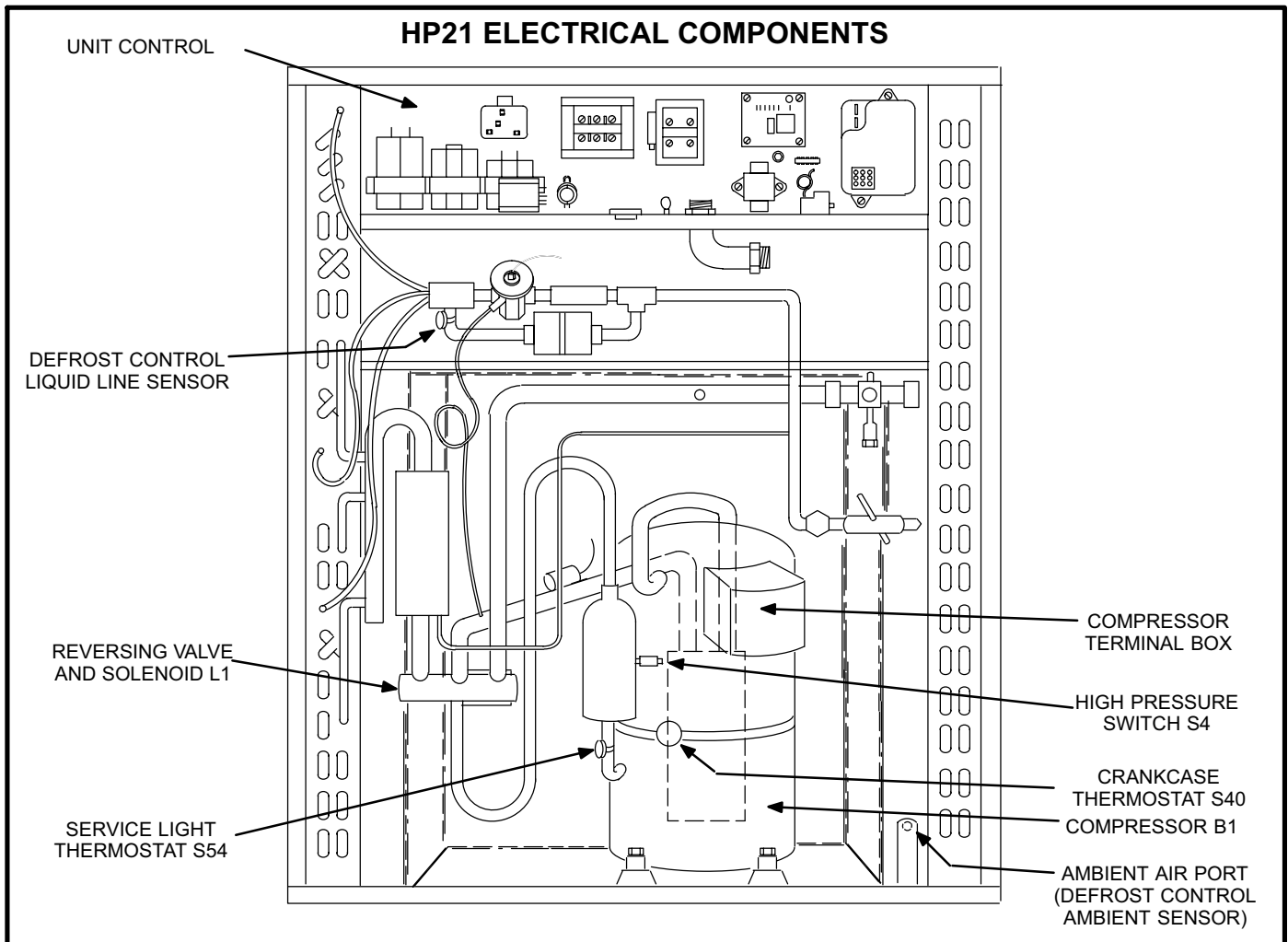

FIGURE 1

I-APPLICATION

All major components (indoor blower/coils) must be matched according to Lennox recommendations for the compressor to be covered under warranty. Refer to Engineering Handbook for approved system matchups. A misapplied system will cause erratic operation and can result in early failure of compressor or other components.

II-UNIT COMPONENTS

A-Control Transformer T19

All units are equipped with a line voltage to 24VAC transformer which supplies power to unit controls as shown in table 1. Refer to unit wiring diagram for detailed information regarding unit wiring.

B-Contactors K1 and K69

The compressor is energized by a set of contactors located in the control box. Contactors in HP21 units are energized as shown in table 2.

TABLE 1

HP21 Component	Source of Power
Two-Speed Control A14	24VAC from Outdoor Unit Transformer T19
Contactor K1	
Contactor K69	
High Pressure Limit S4	
Crankcase Thermostat S40	
Defrost Control CMC1	24VAC from Indoor Unit Transformer T1
Defrost Relay K4	
Speed Control Thermostat S55	
Service Light Thermostat S54	
Ambient Thermistor RT3	
Potential Relay K31	Line Voltage
Crankcase Heater HR1	
Compressor Run Capacitor C5	
Compressor Start Capacitor C7	
Bleed Resistor R21	
Fan Capacitor C1	
Compressor B1	
Outdoor Fan B4	

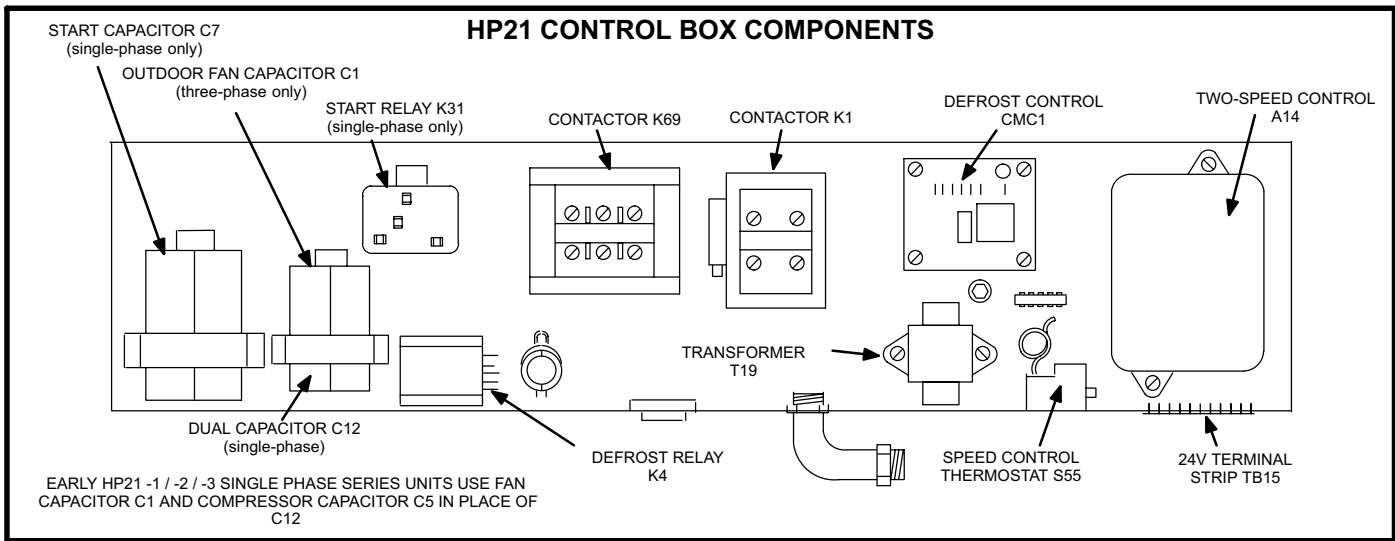

FIGURE 2

Contactor K1

Contactor K1 energizes low speed compressor operation in all units (single-phase and three-phase.) In single-phase units K1 is a two pole contactor with two sets of normally open contacts and in three-phase units K1 is a five pole contactor with three sets of normally open contacts and two sets of normally closed contacts. K1 is also equipped with a set of single-pole double-throw auxiliary contacts located on the side of the contactor. The contactor is energized in response to low speed thermostat demand (from two-speed control jackplug J44/P44 pin 9.)

Contactor Operation: Single-Phase Units

Low speed demand energizes K1. K1 de-energizes the crankcase heater and energizes the compressor. High speed demand energizes both contactors K1 and K69. K69 N.O. contacts close to redirect the circuit to the high speed start windings and the N.C. contacts open to de-energize the low speed start windings. K69 N.C. contacts also switch whenever K69 is energized to ensure that K1 is energized with K69 during high speed operation (refer to unit wiring diagram).

Contactor Operation: Three-Phase Units

Low speed demand energizes K1. K1 energizes the compressor and locks out contactor K69. High speed demand de-energizes K1 and energizes contactor K69. K69 locks out K1 and energizes the compressor on high speed. K1 is wired so that when de-energized, the contactor forms a parallel common connection to the motor windings for high speed forming a parallel “Delta” connection for Copeland compressors. When K1 is energized, the contactor forms a series Delta connection to the compressor windings. Refer to operation sequence in back of this manual for more information.

TABLE 2

Compressor Speed	Contactors Energized	
	Single-Phase	Three-Phase
Low	K1	K1
High	K1 & K69	K69

In single-phase units, K1 also de-energizes the crankcase heater during compressor operation.

Contactor K69

Contactor K69 energizes high speed operation in all units (single-phase and three-phase.) In single-phase units K69 is a five-pole contactor with three sets of normally open contacts and two sets of normally closed contacts. In three-phase units K69 is a three-pole contactor with three sets of normally open contacts. This contact arrangement provides unique switching characteristics for two-speed operation. K69 is also equipped with a set of single-pole double-throw auxiliary contacts located on the side of the contactor. The contactor is energized in response to high speed thermostat demand from JP44-8 (two-speed control jackplug J44/P44 pin 8.)

C-Defrost Relay K4

All HP21 units are equipped with a defrost relay located in the unit control box which controls defrost. The relay is a 3PDT relay powered 24 VAC from the thermostat. K4 is enabled during both cooling and heating modes (except emergency heat). It is only powered when the defrost control is calling for defrost. When energized, the reversing valve and indoor auxiliary heat are energized. Simultaneously, the outdoor fan is de-energized. K4 latches in for the duration of the defrost period.

D-Hard Start Relay K31 (single-phase only)

All single-phase HP21 units are equipped with a hard start relay located in the unit control box which controls the operation of the compressor starting circuit. The relay is normally closed when the compressor (contactor K1) is de-energized. Capacitor (C7) is connected in series to a set of normally closed K31 contacts and assists the compressor in starting. When K1 energizes, the compressor immediately begins start-up. K31 remains de-energized during compressor start-up and the start capacitor (C7) remains in the circuit. As the compressor gains speed K31 is energized by electromotive forces generated by the compressor. When K31 energizes, its contacts open to take the start capacitor out of the circuit.

E-Terminal Strip TB15

All HP21 units are equipped with a low voltage terminal strip located in the unit control box for making up thermostat wiring connections (refer to figure 2).

F-Compressor B1

See ELECTRICAL DATA or compressor nameplate for specifications. Figure 3 shows the compressor terminal box. All compressors are equipped with internal pressure relief valves set at 450 ± 50 psig. Compressors in all units use insertion type crankcase heaters which are regulated by relays in the HP21.

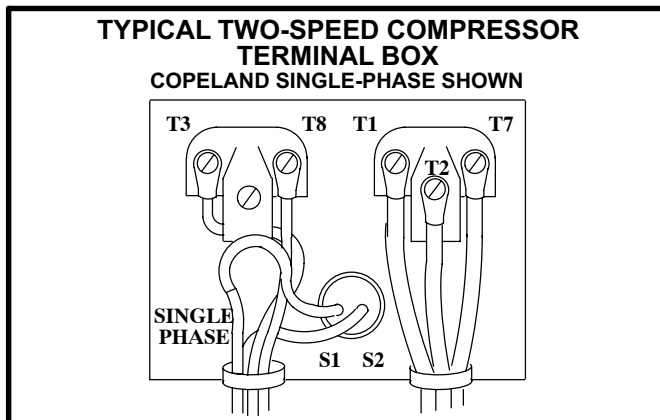

FIGURE 3

G-Outdoor Fan Motor B4

The specifications table on page 1 of this manual shows the specifications of outdoor fans used in all HP21 units. In single-phase units, the outdoor fan is controlled by the compressor contactor and is de-energized when the de-

frost relay is energized. In three-phase units, the outdoor fan is controlled by contactor K10 and is de-energized when the defrost relay is energized. See figure 4 if outdoor fan motor replacement is necessary.

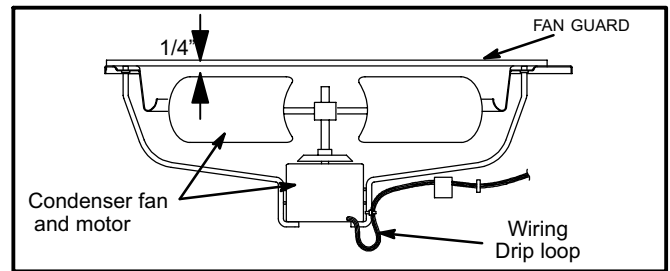

FIGURE 4

H-High Pressure Limit S4

All units are equipped with a high pressure limit mounted on the compressor discharge line. The switch can be manually reset and has a "cutout" point of 410 ± 10 psig. The switch is electrically connected in series with crankcase thermostat S40 in the two-speed control's safety circuit. When tripped, the TSC interrupts unit operation. If the high pressure switch "trips" three times within the same thermostat demand, the two-speed control locks out and the contactor cannot energize.

Although the high pressure limit must be reset manually, if the two-speed control is locked out it must be reset before the unit can operate. To reset the control, break and re-make thermostat demand.

I-Crankcase Thermostat S40

Crankcase thermostat S40 is electrically connected in series with high pressure limit S4 in the two-speed control's safety circuit. It is used in all units to monitor the temperature of the compressor. The switch is a N.C. SPST "belly-band" thermostat strapped to the compressor. The switch is factory preset to trip at $190^\circ\text{F} \pm 5^\circ\text{F}$ on a temperature rise. When tripped, the TSC interrupts unit operation. The crankcase thermostat automatically resets when the compressor crankcase drops below $110^\circ\text{F} \pm 7^\circ\text{F}$. If the crankcase thermostat "trips" three times within the same thermostat demand, the two-speed control locks out and the contactor cannot energize. If the two-speed control is locked out it must be reset before the unit can operate. To reset the control, break and remake thermostat demand.

J-Service Light Thermostat S54

All units are equipped with a service light thermostat mounted on the compressor discharge line. The switch is electrically connected to the service light in the indoor thermostat. When compressor discharge line temperature reaches $130\pm 5^{\circ}\text{F}$, the switch opens. If discharge line temperature drops below $110\pm 5^{\circ}\text{F}$ during unit operation (indicating a problem in the system), the switch closes. If thermostat demand is present when S54 closes, the service light is powered to indicate service is needed.

K-Start Capacitor C7

All single-phase HP21 units are equipped with a start capacitor connected in parallel with the run capacitor. The capacitor is switched off by the potential relay when the compressor nears full speed. The start capacitor is rated 145-175mfd. @ 330VAC in all single-phase units.

Three-phase HP21 units do not use start capacitors.

L-Bleed Resistor R21

All single-phase HP21 units are equipped with a bleed resistor connected in parallel with start capacitor C7. The resistor is used to slowly discharge the capacitor when not in use. R21 is a 15,000 ohm 2 watt resistor.

M-Run Capacitor C5

All single-phase early model HP21 -1 / -2 / -3 units use a compressor run capacitor to maximize motor efficiency. The run capacitor is located in the unit control box and is electrically connected as shown in the unit wiring diagram. Run capacitors are wired in parallel with the start capacitor. See side of capacitor for ratings.

N-Fan Capacitor C1

All early model HP21 -1 / -2 / -3 single phase and all HP21 three-phase series units (regardless of dash number) use single-phase PSC outdoor fan motors which require an external run capacitor. The fan capacitor is located inside the unit control box. See side of fan capacitor for ratings.

O-Dual Capacitor C12

HP21-4 / -5 and late model single-phase units use a single dual capacitor to maximize motor efficiency in both the fan motor and the compressor, which use PSC motors. A dual capacitor has two independent capacitors inside one can. Each side of the capacitor has different ratings. See side of capacitor for ratings. The dual capacitor is wired in parallel with the start capacitor and is electrically connected as shown in the unit wiring diagram.

P- Two-Speed Controls

ELECTROSTATIC DISCHARGE (ESD)

Precautions and Procedures

CAUTION

Electrostatic discharge can affect electronic components. Take precautions during unit installation and service to protect the unit's electronic controls. Precautions will help to avoid control exposure to electrostatic discharge by putting the unit, the control and the technician at the same electrostatic potential. Neutralize electrostatic charge by touching hand and all tools on an unpainted unit surface before performing any service procedure.

TSC-2 Two-Speed Control

The TSC two-speed control (figure 5) is a Lennox built control designed for use with two-speed condensing units and heat pumps. The control provides automatic switching from low speed to high speed operation and back. The TSC-2 is designed for use with Bristol and Copeland compressors. All HP21 series units use Copeland compressors. All early model HP21-1 units use the TSC-2 controls.

The TSC two-speed control contains relays which energize compressor operation in response to thermostat demand. High speed operation can be energized and de-energized without passing through low speed. The control also contains safety timed-off delays and compressor over-temperature sensing which help protect the compressor.

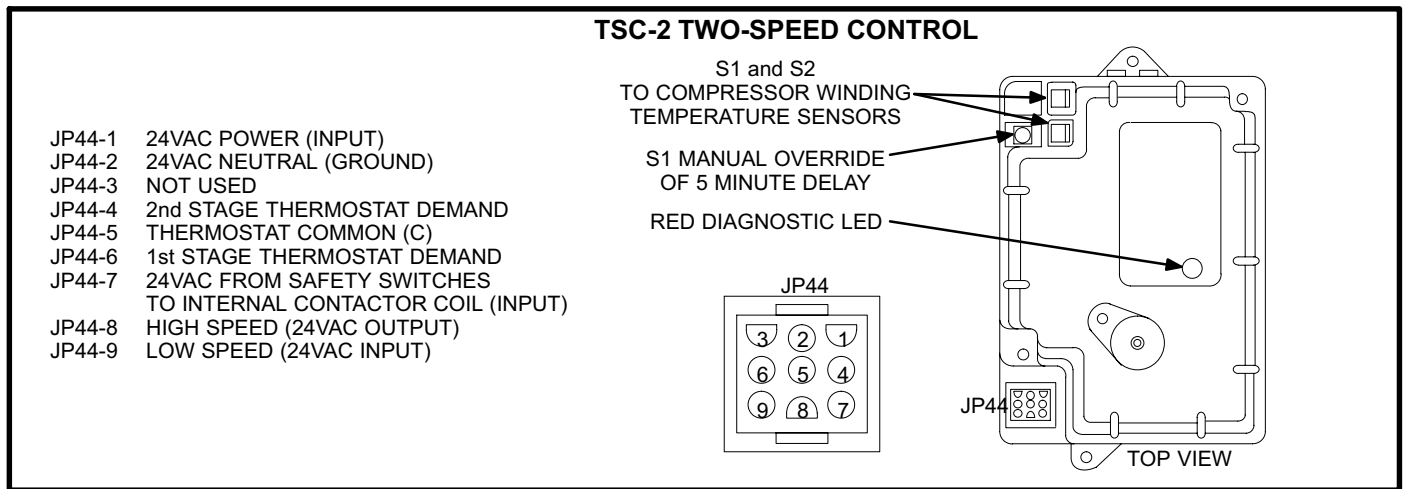

A timed-off delay in the control prevents the compressor from operating for five minutes after the end of a thermostat demand or after a power failure to prevent short cycling (see miscellaneous section.) The control also counts “unit fault conditions.” Whenever the compressor stops due to a safety limit trip or if the compressor winding temperature becomes too hot, the control’s internal cycle counter accumulates one fault. If three unit faults are counted during the same thermostat demand, the control “locks out” and stops all unit operation. The control can be reset by breaking and remaking thermostat demand. Also, unit faults are erased when power is interrupted. When thermostat demand changes stages, compressor operation stops for approximately one minute to allow refrigerant pressure to equalize in the system.

In order to aid servicing and troubleshooting, a manual override button has been placed on the control. The manual override button, when pressed and released, bypasses the five minute delay so low speed or high speed operation can be immediately energized.

A red LED located on the face of the control can be used for diagnostics. The control continually self-tests its internal circuits and uses the diagnostic LED to indicate control failure or Safety Dormant Lockout. A Safety Dormant Lockout is caused by abnormal line voltage (such as a lightning strike near the unit).

Normal Operation Sequence

- 1- General Operation
On power-up, the control begins a ten second initial power-up delay.
- 2- The control then begins a five minute delay during which the unit is not operational (control and outdoor unit do not respond to thermostat demand.) Once the five minute delay is complete, the control waits in “OFF” mode for thermostat demand.
- 3- After receiving a thermostat demand, the TSC delays three seconds before responding.
- 4- Low speed demand (JP44-6) energizes low speed operation (JP44-9) OR high speed demand (JP44-4) energizes high speed operation (JP44-8.)
- 5- During unit operation, if low speed demand changes to high speed demand or if high speed demand changes to low speed, the control delays three seconds before responding. Then, all unit operation stops for 60±5 seconds (control de-energizes JP44-8 and JP44-9.) This allows refrigerant pressure to equalize in the system. At the end of the 60±5 second delay, the control responds to whatever thermostat demand is present. If no thermostat demand is present, the control resets (see unit fault conditions section) and the control returns to step 2 above.
- 6- If thermostat demand stops compressor operation, all unit operation stops after a three second delay (control de-energizes JP44-8 and JP44-9,) the control resets (see unit fault conditions section) and the control returns to step two.

Two-Speed Control Fault Conditions

If the control is in low speed operation, high speed operation, "OFF" mode or speed change delay, the control "counts" or accumulates faults on an internal cycle counter. Only faults which occur during compressor operation and which cause the compressor to shut off are counted. After a fault is counted, the control stops unit operation, resets and begins a five minute time delay (step 2, operation sequence). If the control senses a fault at the end of five minutes, the unit will not restart. If the control counts three faults during the same thermostat demand, the control locks out unit operation.

NOTE-If the control locks out, it can be reset by breaking thermostat demand for about five seconds then remaking thermostat demand. Also, anytime thermostat demand is removed or power is interrupted, the control resets to zero faults.

A fault occurs when

- 1- Compressor operation is monitored by high pressure switch and crankcase temperature thermostat. These controls are wired in series. If either one trips, compressor operation is interrupted and one fault is counted. High pressure switch must be reset manually but crankcase temperature switch resets automatically.

IMPORTANT-If the cycle counter counts three faults during the same thermostat demand, the control locks out. The outdoor unit remains inoperable until thermostat demand is broken. This indicates further troubleshooting is needed. Though the control can be reset by breaking thermostat demand, the unit may remain inoperable. The high pressure or high temperature conditions may still exist and must be located and corrected before the unit can be placed back in service.

It is likely that the control could count three unit faults from the crankcase temperature switch during a single thermostat demand since this switch resets automatically. However, the cycle counter can only count unit faults from the high pressure switch if the reset button is pushed without interrupting thermostat demand.

- 2- On all units using the TSC two-speed control, terminals S1 and S2 on the control are connected to temperature sensors (thermistors) which monitor the temperature of the compressor motor windings. The two-speed control measures the resistance through the sensors. The sensors increase their resistance as temperature increases (for example, too much superheat). When the resistance through the sensors increases above a preset limit, the control stops compressor operation. As the compressor windings cool, the resistance through the sensors drops below the reset limit, the control resets automatically and one fault is counted.

NOTE-Intermittent continuity (bad connection or failing components) can cause false lockout or lit LED. Check all electrical connections thoroughly.

The sensors can be checked by measuring resistance (ohms) through the sensors with the wires disconnected from the control (unit not running). The sensor wires are not polarity sensitive. Table 3 shows winding temperature sensor resistance values which will cause the TSC to lock out. When the unit is operating normally, the resistance through the sensors should be below the trip value shown in table 3.

The control can be checked by comparing the resistance measured through the sensors to the voltage measured across the sensor terminals with the unit running. Table 4 shows voltage measured across two-speed control terminals S1 and S2 with the compressor running.

TABLE 3

Compressor Winding Temperature Sensor	Trip Ohms Temp. Rise	Reset Ohms Temp. Fall
TSC-2 Bristol or Copeland Compressor	25K to 35K	8.4K to 10K

Two-Speed Control Manual Override

The manual override button is designed to be an aid in servicing and troubleshooting the control or the unit. When the button is pushed and then released, the control bypasses the five minute override delay.

TABLE 4

COMPRESSOR WINDING SENSOR OPERATING RANGE

Resistance Through Compressor Winding Temperature Sensor K-ohms (ohms x 1000)	Voltage Across TSC Terminals S1 and S2 with Unit Running DC Volts \pm .15	
0	.02	} Reset Range
1.0	.92	
5.5	3.4	
6.9	3.9	
8.4	4.3	
10.0	4.7	
16.0	5.6	
20.0	6.0	} Trip Range
24.0	---	
25.0	6.3	
30.0	6.8	
35.0	7.0	

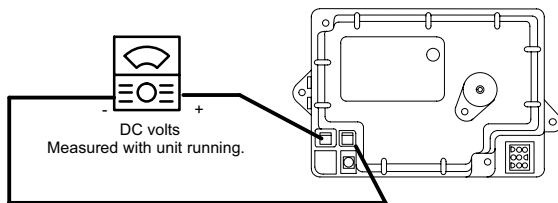

Do not use the override button for eleven seconds after power-up. If the button is pushed during the ten second power-up delay, the button has no effect. The control completes the five minute delay.

LED "OFF"

MAY MEAN "UNIT FAULT" CONDITION

If the unit will not run and the LED is *not* lit, a unit lockout condition is indicated. Breaking and remaking thermostat demand will reset the control. Activate the compressor by pressing and releasing the override button (see illustra-

tion). If compressor starts, the control is good and should not be replaced. Proceed through the troubleshooting flowchart in the Unit Information Manual to locate the source of the lockout. If the compressor does not start, a problem probably exists elsewhere in the unit. Check the unit voltage and proceed through the unit troubleshooting flowchart in the Unit Information Manual.

LED "ON"

MEANS "TSC FAULT" CONDITION

If the unit will not run and the LED is lit, the TSC may be in Safety Dormant Lockout (a lockout caused by self-test failure or high voltage spike).

To determine if the control is in Safety Dormant Lockout, briefly turn off power at the disconnect. When power is restored, check the LED. If the LED is lit, the control is damaged and must be replaced. If the LED is not lit, the control is probably good and should not be replaced until eliminated by all other checks. Confirm this by activating the compressor (press and release the override button with thermostat demand present). If the compressor starts, the control was in safety dormant lockout (due to high voltage spike or self-test failure) and the control should not be replaced. If the compressor does not start, the control is probably good and the problem is located elsewhere in the unit. Proceed through the troubleshooting flowchart to locate the problem. Start by checking all manually reset controls (high pressure switch etc...)

Service Instructions:

- 1- If light comes on and stays lit, turn off power at disconnect for at least 3 seconds.

NOTE-Breaking thermostat demand will not reset the control if the control is in a Safety Dormant Lockout.

- 2- If LED is on when power is restored, replace TSC.
- 3- If light goes out see troubleshooting flowchart in Unit Information Manual.

TSC-3 Two-Speed Control

All early model HP21 -2 series units (single and three phase) are equipped with a TSC-3 two-speed control. The speed-control thermostat (formerly key number S55) has been removed from the unit and incorporated into the circuitry of the TSC-3 control (see figure 6). The function and operating sequence are otherwise identical to the TSC-2 plus the separate thermostat used in previous HP21 units.

The purpose of the speed control thermostat is to force the compressor to operate on high speed when outdoor temperature is low. It initiates a speed change delay and automatically energizes high speed when temperature drops below the setpoint. The setpoint is factory preset and can be field adjusted.

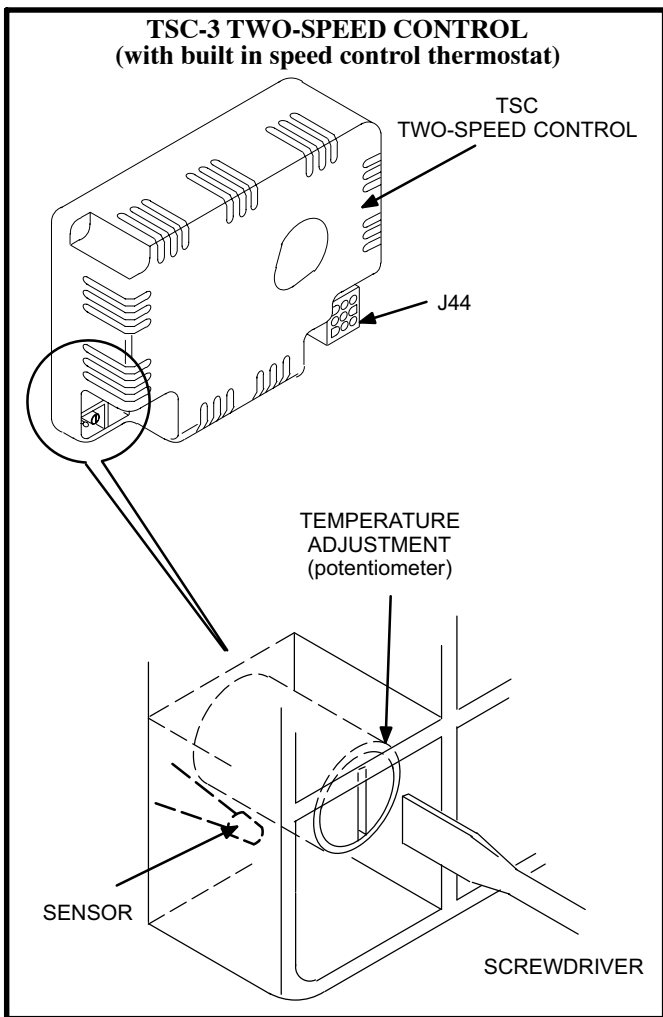

FIGURE 6

When temperature rises above the setpoint, the control initiates a speed change delay and automatically energizes low speed.

The setpoint can be changed by adjusting the potentiometer shown in figure 6. The potentiometer is factory set as shown in table 5.

TABLE 5

Speed Control Thermostat Adjustable Range	Min.	Mid.	Factory Setting	Max
Cut-In (Close on Temperature Drop)	37±2°F	46±2°F	42±2°F	55±2°F
Cut-Out (Open on Temperature Rise)	47±2°F	56±2°F	52±2°F	65±2°F

To adjust the speed control thermostat, insert a small slot screwdriver into the potentiometer as shown in figures 6 and 7. To lower the setpoint, turn the potentiometer counter-clockwise. To raise the setpoint, turn the potentiometer clockwise. Do not force the potentiometer to turn past its stops; the potentiometer will be damaged.

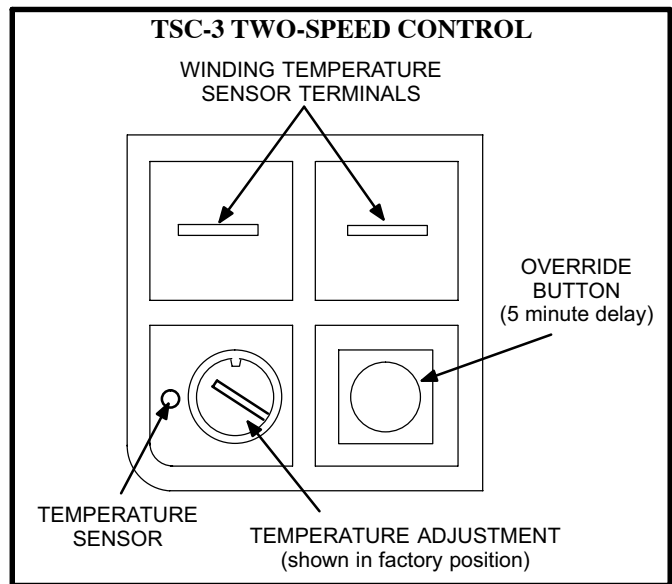

FIGURE 7

The unit wiring diagrams have been revised to reflect the changes for the HP21-2 (TSC-3), and are shown in section VII-Wiring Diagrams and Operation Sequence.

TSC-6 Two-Speed Control

HP21 -4 and -5 and late model HP21 units (single and three phase) are equipped with a TSC-6 two-speed control. The TSC-6 (A14) two-speed control contains relays which energize compressor operation in response to thermostat demand. High speed operation can be energized and de-energized without passing through low speed. The control also contains safety timed-off delays and compressor over-temperature sensing which protect the compressor. The control has an external temperature probe to lock out low speed during low temperatures, plus a potentiometer used for setting the low speed lock out temperature. The adjustment range is 38° F (3.3° C) to 55° F (12.7° C) $\pm 2^\circ$ F (1.1° C). This lock out will occur in both heating and cooling modes.

A timed-off delay in the control prevents short cycling by locking out compressor operation for five minutes after the end of a thermostat demand or after a power failure. The control also counts "unit fault conditions." When the compressor stops due to a safety limit trip, or if the compressor winding temperature becomes too hot, the control's internal cycle counter accumulates one fault. If three unit faults are counted during the same thermostat demand, the control "locks out" and stops all unit operation. The control can be reset by breaking and remaking thermostat demand. Unit faults are erased when power is interrupted. When thermostat demand changes stages, compressor operation stops for approximately one minute to allow refrigerant pressure to equalize in the system.

A manual override button aids servicing and troubleshooting, on the control. The manual override button, when pressed and released, bypasses the five-minute delay so low speed or high speed operation can be immediately energized. However, the control provides a one-minute delay between speed changes, which cannot be bypassed.

Do not use the override button immediately after power-up. If the button is pushed during the ten-second power-up delay, it has no effect. The control completes the five-minute delay.

The control continually self-tests its internal circuits and uses the diagnostic lights to indicate control failure.

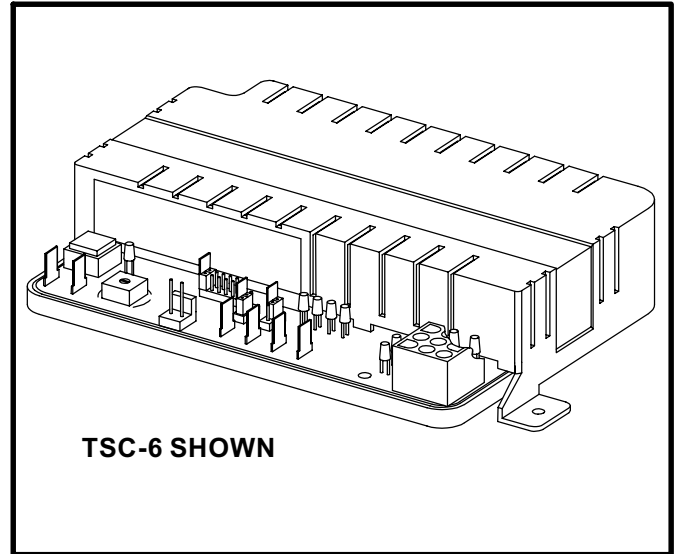

Normal Operation Sequence

- 1- After self-test, the control begins a five-minute delay during which the unit is not operational (control and outdoor unit do not respond to thermostat demand). Once the five-minute delay is complete, the control waits in "OFF" mode for thermostat demand.
- 2- After receiving a thermostat demand, the TSC delays three seconds before responding.
- 3- Low speed demand (JP44-9) energizes low speed operation OR high speed demand (JP44-8) energizes high speed operation.
- 4- During unit operation, if low speed demand changes to high speed demand or if high speed demand changes to low speed, the control delays three seconds before responding. Then, all unit operation stops for 60 \pm 5 seconds (control de-energizes JP44-8 and JP44-9). This allows refrigerant pressure to equalize in the system. At the end of the 60 \pm 5 second delay, the control responds to whatever thermostat demand is present. If no thermostat demand is present, the control resets (see unit fault conditions section) and returns to step 2 above.
- 5- When thermostat demand is satisfied, all unit operation stops after a three-second delay (control de-energizes JP44-8 and JP44-9), the control resets (see unit fault conditions section) and returns to step two.
- 6- General Operation
On power-up, the control begins a ten-second initial delay.

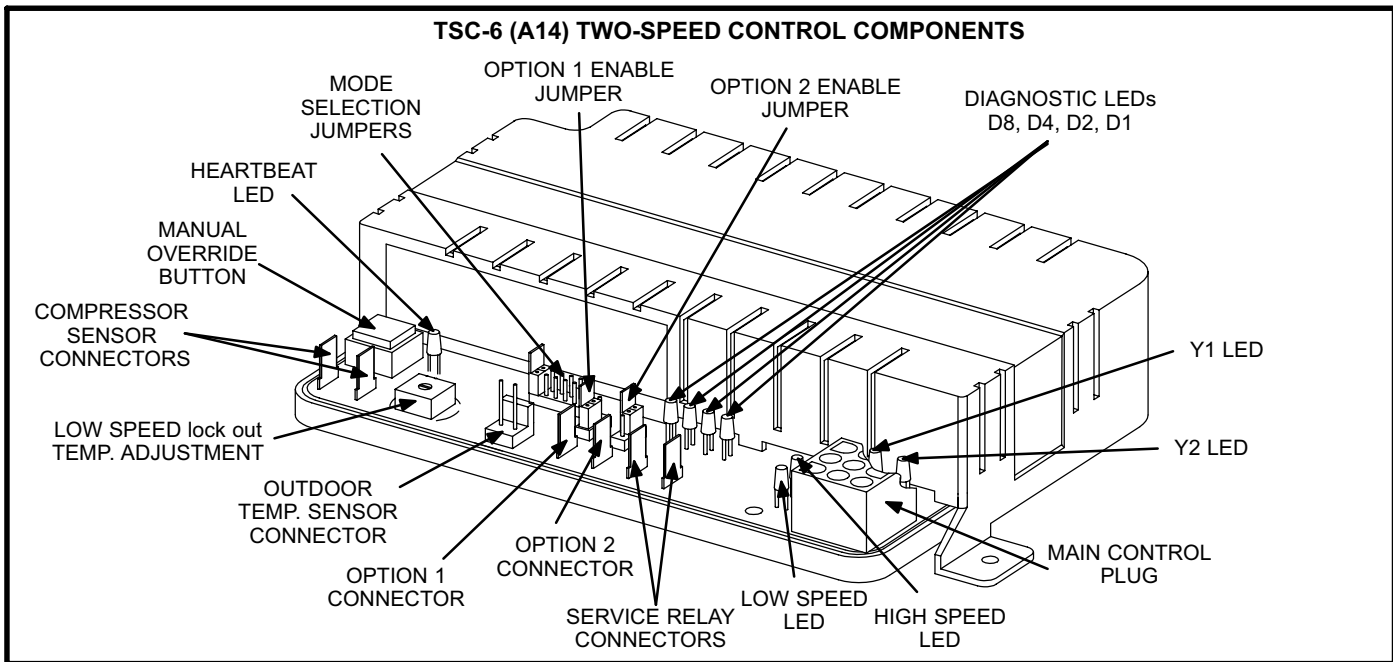

FIGURE 8

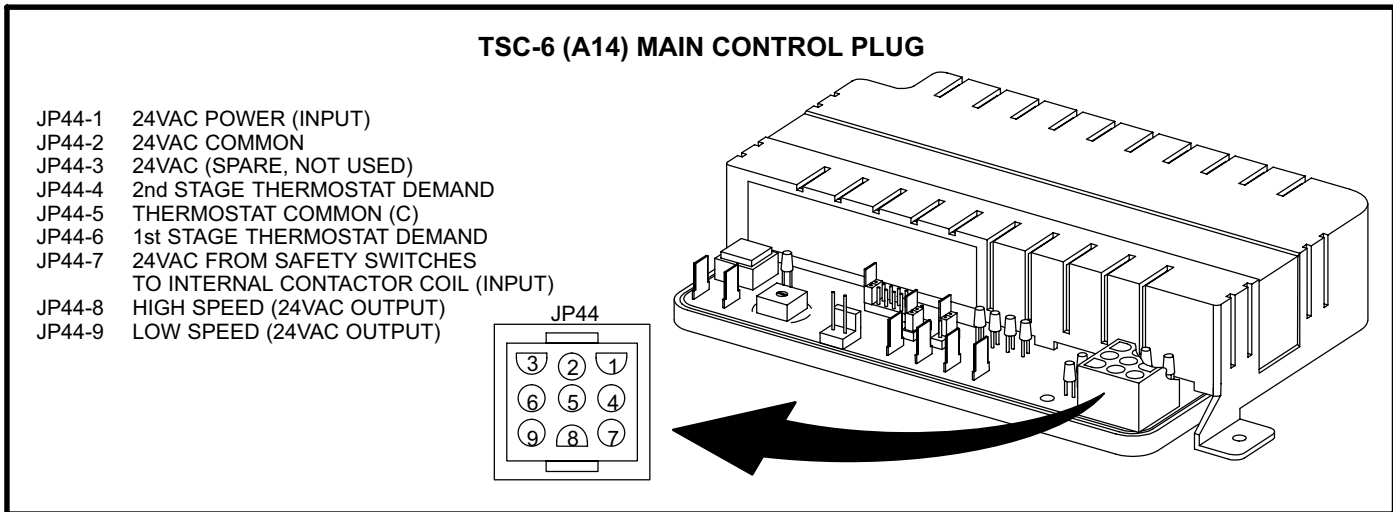

FIGURE 9

Two-Speed Control Fault Conditions

If the control is in low speed operation, high speed operation, "OFF" mode or speed change delay, the control "counts" or accumulates faults on an internal cycle counter. Only faults which occur during compressor operation and which cause the compressor to shut off are counted. After a fault is counted, the control stops unit operation, resets and begins a five-minute time delay (step 2, operation sequence). If the control senses a fault at the end of five minutes, the unit will not restart. If the control counts three faults during the same thermostat demand, the control locks out unit operation.

⚠ IMPORTANT

If the cycle counter counts three faults during the same thermostat demand, the control locks out. The outdoor unit remains inoperable until thermostat demand is broken. This indicates further troubleshooting is needed. Though the control can be reset by breaking thermostat demand, the unit may remain inoperable. The high pressure or low pressure conditions may still exist and must be located and corrected before the unit can be placed back in service. See diagnostic codes to determine problem.

⚠ IMPORTANT

If the control locks out, it can be reset by breaking thermostat demand for about five seconds then re-making thermostat demand. Also, anytime thermostat demand is removed or power is interrupted, the control resets to zero faults.

A fault occurs when:

- Compressor operation is monitored by high and low pressure switches. These controls are wired in series. If either one trips, compressor operation is interrupted and one fault is counted. The control locks out compressor operation for a minimum of five minutes when a safety device terminates operation. High pressure switch must be reset manually but low pressure switch resets automatically.

It is likely that the control could count three unit faults from the low pressure switch during a single thermostat demand since this switch resets automatically. However, the cycle counter can only count unit faults from the high pressure switch if the reset button is pushed without interrupting thermostat demand.

- On all units using the TSC two-speed control, terminals S1 and S2 on the control are connected to temperature sensors (thermistors) which monitor the temperature of the compressor motor windings. The two-speed control measures the resistance through the sensors. The sensors increase their resistance as temperature increases (for example, too much superheat). When the resistance through the sensors increases above a preset limit, the control stops compressor operation for a minimum of five minutes. As the compressor windings cool, the resistance through the sensors drops below the reset limit, the control resets automatically and one fault is counted.

Check sensors by measuring resistance (ohms) through the sensors with the wires disconnected from the control (unit not running). The sensor wires are not polarity sensitive. Table 6 shows winding temperature sensor resistance values which will cause the TSC to lock out. When unit is operating normally, resistance through the sensors should be below the trip value shown in table 6.

TABLE 6

Compressor Winding Temperature Sensor	Normal Ohms	Trip Ohms Temp Rise	Reset Ohms Temp Fall
TSC-6 Copeland Compressor	90 - 7800	25K - 35K	8.4K - 10K

IMPORTANT - Normal resistance values of these compressors are above 200 ohms but can read 90 ohms during certain ambient temperatures. Ohm value below 200 ohms will cause the two-speed control to cycle the compressor "off" and will not allow the compressor to cycle back "on" until the ohm values are above 200 ohms.

To prevent this issue, the field can install a 150 ohm - 1/4

watt resistor in series with one of the sensor connections on the two-speed control. (The resistor can be found at electronic stores such as Radio Shack). Table 7 shows the resistor in series with the control and compressor.

The control can be checked by comparing the resistance measured through the sensors to the voltage measured across the sensor terminals with the unit running. Table 7 shows voltage measured across two-speed control terminals S1 and S2 with the compressor running.

TABLE 7

COMPRESSOR WINDING SENSOR OPERATING RANGE

Resistance Through Compressor Winding Temperature Sensor K-ohms (ohms x 1000)	Voltage Across TSC-6 compressor sensor terminals with Unit Running DC Volts	
.090 - .200	0	Short in Sensor
1.0	1.70 - 1.82	
5.5	6.07 - 6.48	
6.9	6.86 - 7.33	Reset Range
8.4	7.55 - 8.07	
10.0	8.16 - 8.72	
16.0	9.69 - 10.36	
20.0	10.34 - 11.05	
24.0	10.82 - 11.57	Trip Range
25.0	10.93 - 11.68	
30.0	11.35 - 12.14	
35.0	11.68 - 12.48	

DC volts
Measured with unit running.

Resistor
S1
S2
Compressor

MODE SELECTION JUMPERS

The control has six mode selection jumpers for selection of operating modes and problem code recall or test. Choose one of the first four modes for operation.

Normal: Normal operation (default mode). Unit runs on high or low speed as the indoor thermostat load demands.

Latch 1: After high speed demand is met, the unit remains in high speed until the low speed demand is satisfied.

Latch 2: After the unit operates in low speed for 15 minutes consecutively, it switches to high speed until low speed demand is satisfied.

Latch 3: After the unit operates in low speed for 30 minutes consecutively, it switches to high speed until low speed demand is satisfied.

Recall: Used in conjunction with the bypass button to recall the stored problem codes.

Test: Used in conjunction with the control button to start test mode.

Latch 2 or 3 modes are recommended in high humidity areas. If the jumper falls off or is removed, the control will continue to operate in the previously set mode until the control is reset due to loss of power, then the control will default to the Normal mode.

TEST MODE

The control has a test mode. To initiate this mode, move the jumper to the test position and push the control button. The unit will operate in low speed for 10 seconds, turn off for ten seconds, then operate in high speed for 10 seconds. The control will only go into the test mode if there is no thermostat demand and 5 minutes has elapsed since the unit ran. The indoor blower does not run during this mode. The test mode cannot run more than once every 5 minutes.

LED LIGHTS

Y1 and Y2 lights are connected directly to the inputs from the thermostat. They indicate low and high speed demand, respectively.

The HI and LO lights are connected directly across the contactor coils. They indicate if the high and low speed contactors are energized.

The HEARTBEAT light is connected to the microcontroller unit (MCU). It indicates when the control's MCU is operating correctly, and also when the control is in delay mode. It blinks at a rate of four times a second when the MCU is operating properly and at a rate of once every two seconds when in the delay mode (such as the 1 or 5 minute delay). If the LED is continuously on or off (assuming the power is on), the MCU is not operating properly and the control needs to be replaced.

The D1, D2, D4, and D8 (see figure 8) diagnostic lights display diagnostic codes to aid in unit troubleshooting. Refer to Diagnostic Code Table (table 8).

Diagnostic Code Display

A problem code is normally displayed only for the duration of the error. There is one exception. During a lock out, the code for the problem causing the lock out flashes once a second even if the problem condition no longer exists. If other problems occur during a lock out condition, the codes for those problems will be saved in memory, but not displayed. The stored problem codes are displayed by recalling them from memory. The diagnostic codes can be re-displayed by setting the jumper to the recall position. The stored codes are dis-

played by pushing the push button. As previously mentioned, the push button is used to bypass the five-minute delay and to initiate the test mode. In addition, the button is used to step back through the stored diagnostic codes and erase the diagnostic code memory. Diagnostic codes are recalled in the reverse order of actual occurrence. Each subsequent button push will display additional codes until the last one, which will stay on with additional button pushes. Hold the button down until the lights go off (approximately five seconds) to erase the memory. The control has a nonvolatile memory that stores the 63 most recent diagnostic codes. These codes are stored in memory, even in the event of a power loss.

Not all codes cause lock outs or indicate problems. The purpose of the diagnostic lights is to let the installer or service technician know what is going on with the entire system, not just the two-speed control. Some codes do indicate malfunctions or problems with either the control or the HP21, while others inform the technician of the unit's status. All codes, except for three, are stored in memory and may be recalled.

Code 1 - Power Loss for Two Electrical Cycles

This code indicates that the unit's power skipped two electrical cycles (33-40 milliseconds). It may suggest that power to the unit is "dirty" or is of low quality. Code 1 is stored.

Code 2 - Input Indication

This code indicates that a change has been made and that the control acknowledges the change. It does not indicate a problem condition. It indicates activity such as jumper setting changes, delay overrides, or addition of an optional safety device to Option 1 or 2. Code 2 is not stored.

Code 3 - Unsteady Thermostat Input

Code 3 indicates intermittent inputs from the room thermostat. Most likely, there is a loose connection at the thermostat when this condition appears. Code 3 is stored.

Code 4 - Pressure Switch Opens < Two Minutes

If the low or high pressure switch opens after the compressor has run for **less than** two minutes, Code 4 will be displayed. This may indicate blockage or fan failure. Code 4 is stored. If the unit still operates after code is displayed, the low pressure switch stops operation (low pressure is auto-reset). Check for low system charge.

Code 5 - Pressure Switch Opens > Two Minutes

If the low or high pressure switch opens after the compressor has run for **more than** two minutes, Code 5 is displayed. This may indicate an improper charge or coil obstruction. Code 5 is stored. If the unit still operates after code is displayed, the low pressure switch stops operation (low pressure is auto-reset). Check for low system charge.

Code 6 - Hot Compressor < Five Minutes

Code 6 indicates the compressor temperature exceeded its limit after running **less than** five minutes. Code 6 is stored.

**TABLE 8
TSC-6 DIAGNOSTICS CODES**

CODE NUMBER	CONDITION	DISPLAY LIGHTS			
		8	4	2	1
1	Power loss for two cycles	OFF	OFF	OFF	ON
2	Input Indication	OFF	OFF	ON	OFF
3	Unsteady Input	OFF	OFF	ON	ON
4	Pressure Switch Open <2 minutes	OFF	ON	OFF	OFF
5	Pressure Switch Open > 2 minutes	OFF	ON	OFF	ON
6	Hot Compressor < 5 min. (or open sensor)	OFF	ON	ON	OFF
7	Hot Compressor > 5 min. (or open sensor)	OFF	ON	ON	ON
8	Option 1 < 5 minutes	ON	OFF	OFF	OFF
9	Option 1 > 5 minutes	ON	OFF	OFF	ON
10	Option 2 Open	ON	OFF	ON	OFF
11	Compressor Temp. Sensor Problem	ON	OFF	ON	ON
12	Outdoor temperature Sensor	ON	ON	OFF	OFF
13	Not Used	ON	ON	OFF	ON
14	Test Mode	ON	ON	ON	OFF
15	No Jumper in place Indication	ON	ON	ON	ON

Code 7 - Hot Compressor > Five Minutes

Code 7 indicates the compressor temperature exceeded its limit after running **more than** five minutes. Code 7 is stored.

Code 8 - Option 1 < Five Minutes

Code 8 occurs if the Option 1 safety device switch opens after the compressor runs **less than** five minutes. Code 8 is stored.

Code 9 - Option 1 > Five Minutes

Code 9 occurs if the Option 1 safety device switch opens after the compressor runs **more than** five minutes. Code 9 is stored.

Code 10 - Option 2

Code 10 is displayed if the Option 2 safety device switch opens. Code 10 is stored.

Code 11 - Compressor Temperature Sensor Shorted

This code indicates that the compressor temperature sensor wires have shorted together. Code 11 is stored.

Code 12 - Outdoor Temperature Sensor

This code indicates a problem with the operation of the outdoor temperature sensor. Code 12 is stored.

Code 13 - Not Used

This code may be used in future models of the two-speed control, but at this time has no function and, therefore, is not stored.

Code 14 - Test Mode

Code 14 does not indicate a problem. The control is in TEST mode when this code is displayed. See Mode Jumper Selections section.

Code 15 - No Jumper in Place

Code 15 is displayed when the mode jumper is not in place. Make sure jumper is placed securely across the selected set of pins for the appropriate mode of operation.

SERVICE RELAY

The control has a built-in service relay. This relay controls the thermostat service light or communicates with an alarm device. The relay signals the alarm device in such a manner that the alarm device can distinguish between a lock out and a non-lock out condition. The relay contacts are normally open when no problems or lock out conditions occur. A non-lock out condition is reported by closing the contacts for the duration of the next no-demand period. If the control goes into a lock out state, the relay will close and remain closed until the next loss of demand. If the service light on the room thermostat is connected to the service relay, the light will turn on if the control is in a lock out. It will not turn on if the control is detecting non-lock out problems. In order for the service relay to indicate only a lock out condition, one side of the relay must be wired to the alarm and the other side to Y2. During a simultaneous Y1, Y2 demand with a non-lock out condition, the alarm will energize for a very short duration (.2 seconds). If both an alarm device and thermostat service lights are used, an additional external relay may be required depending on thermostat used.

OPTIONAL INPUTS

The control has two optional inputs for additional protection devices. If options 1 or 2 are going to be used, move the three pin mini-jumper to the YES side. OPT 1 input will lock out the compressor on the third count. OPT 2 input will not lock out the compressor at any time, but will display and store the problem code (see Diagnostic code Table). These inputs are designed for normally closed switches connected to 24VAC.

 CAUTION
<p>Do not remove the jumpers unless additional protection controls are going to be installed. If OPT 1 jumper is not connected to the NO pin, the control will lock out the compressor. If OPT 2 is not connected to the NO pin, the display only shows the problem code.</p>

The unit wiring diagrams have been revised to reflect the changes for the HP21-4/-5 (TSC-6), and are shown in section VII-Wiring Diagrams and Operation Sequence.

Q-Speed Control Thermostat S55

(Early Model HP21 -1 series units only)

The indoor thermostat regulates compressor speed when the unit is operating in cooling mode. When the unit is operating in heating mode, speed control thermostat S55 regulates compressor speed.

1st stage heating demand from the indoor thermostat energizes the compressor (Y1 demand). Speed control thermostat S55 controls compressor speed. Additional heating demand from the indoor thermostat (W1 demand) energizes the indoor auxiliary heat.

Speed control thermostat S55 (figure 10) is a SPST thermostat located in the unit control box. The control uses a cap-tube sensor to monitor the temperature inside the control box. The cap-tube sensor is coiled adjacent to the control.

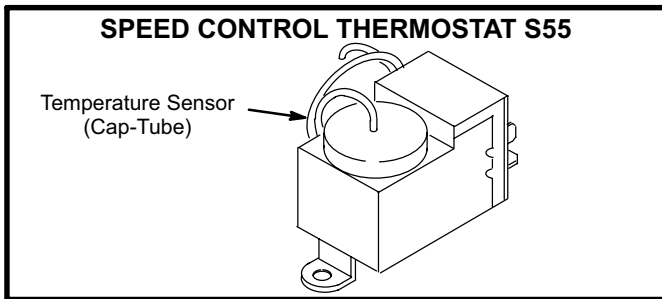

FIGURE 10

S55 continually monitors the temperature inside the control box. When control box temperature drops below the control setpoint, the control closes. When the control closes, the contacts shunt across Y1 and Y2 inside the unit. When heating demand is present and S55 is closed, the two-speed control electrically sees a high speed demand. The compressor operates at high speed until control box warms and S55 opens.

TABLE 9

Speed Control Thermostat Adjustable Range	Min	Factory Setting	Max
Cut-In (Close on Temperature Drop)	37±2°F	40±2°F	55±2°F
Cut-Out (Open on Temperature Rise)	47±2°F	50±2°F	65±2°F

S55 has field adjustable setpoints. Temperature differential (difference between cut-in and cut-out) is fixed and cannot be adjusted. Table 9 shows S55 control setpoints. The control is factory set to close at 40±2°F on a temperature drop and reset at 50±2°F on a temperature rise.

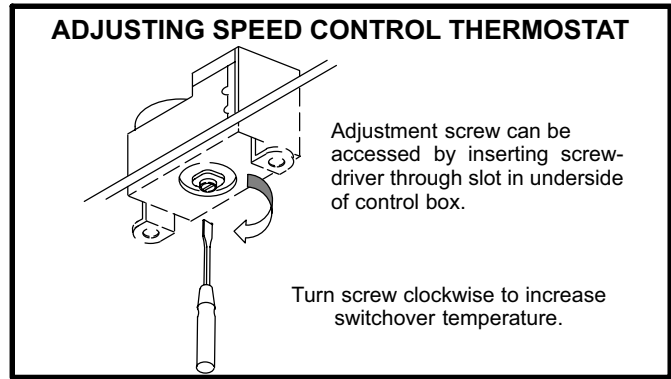

FIGURE 11

Regional climatic conditions may require the control to be adjusted to a different setting. The adjustment screw is located on the bottom of the control. A hole cut into the bottom shelf of the control box provides access to the speed control from the compressor compartment (see figure 11). Figure 12 shows the adjustment range of the control. Turn adjustment screw clockwise to raise the switchover temperature and counter-clockwise to lower the switchover temperature.

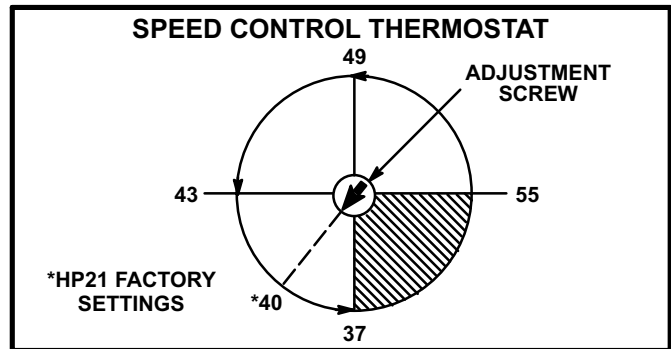

FIGURE 12

R-Reversing Valve and Solenoid L1

A refrigerant reversing valve with electromechanical solenoid is used to reverse refrigerant flow during unit operation. The reversing valve is energized during cooling demand and during defrost.

S-Ambient Compensation Thermistor RT3

HP21 units are equipped with an ambient compensation thermistor (RT3) attached to the outdoor fan motor bracket. The thermistor is connected in series with the heat anticipation resistor inside the indoor thermostat. The thermistor helps to prevent abnormal droop caused by the anticipation resistors. RT3 is a NTC thermistor (negative temperature coefficient; increase in temperature equals decrease in resistance). As outdoor temperature increases, the resistance through RT3 drops. As the resistance across RT3 drops, the current through the heat anticipation resistor increases. Therefore, heat anticipation increases as outdoor temperature decreases. RT3 resistance values are shown in table 10.

TABLE 10

AMBIENT COMPENSATION THERMISTOR	
Ambient Temperature °F	Resistance Through Sensor ohms
32	861
77	260
100	150

T-Defrost Control CMC1

The CMC defrost control (figure 13) is a solid state control manufactured by Ranco. The control provides automatic switching from normal heating operation to defrost mode and back. Once in defrost mode, the control times the defrost period. Defrost time varies dependent on the temperature difference between the liquid line and ambient (outdoor) temperature.

The control monitors ambient (outdoor air) temperature, liquid line temperature and total compressor run time to determine when a defrost cycle is required. Two temperature probes are permanently attached to the control. The red probe is used to measure ambient air temperature and the blue probe is used to measure liquid line temperature. The ambient probe is attached inside the ambient air port located in the lower right corner of the compressor compartment (see figure 1). The liquid line probe is attached to the cooling liquid line adjacent to the expansion valve.

The temperature probes cannot be detached from the control. The control and the attached probes MUST be replaced as a unit. Do not attempt to cut or splice probe wires.

Operation

On compressor startup, the control begins measuring compressor run time. The control measures run time for the current thermostat demand (cycle) and total run time since the last defrost.

Two minutes after receiving a thermostat demand (after two minutes of cycle run time) the control begins to measure liquid line temperature. When the liquid line temperature drops below 39°F, the control begins to monitor ambient temperature and to measure lockout time. Lockout time is defined as the amount of time the heating mode can continue before initiating a defrost. The amount of lockout time which can be accumulated is determined by

ambient temperature as shown in table 11. When the control reaches the amount of lockout time determined by the ambient temperature, the control proceeds to the next step.

TABLE 11

Ambient Temperature °F	Lockout Time (Minutes)	
	HP21-411/-511 HP21-413/-513 HP21-36-230/233 HP21-48-230/233	HP21-651 HP21-653 HP21-60-230/233
19	120	60
20	98	49
21	85	42
22	74	37
23	67	33
24	61	30
25	56	28
26	52	26
27	49	24
28	47	23
29	45	22
30	44	22
31	43	21
32	42	21
33	41	20
34 and above	40	20

When the lockout time as shown in table 11 is satisfied, the control begins to compare the temperature difference between the liquid line and ambient air. Liquid line temperature and ambient air temperature are monitored indefinitely (total run time continues to accumulate). When the actual temperature difference between liquid line and ambient air exceeds a calculated temperature difference, the defrost relay is activated. Table 12 shows how the defrost control calculates the difference.

Defrost will last for for a maximum of 15 minutes or until coil temperature reaches 70°F. An LED on the circuit board indicates control is in defrost mode. Defrost timings are not adjustable. When defrost relay contacts close, compressor total run-time and lockout time are cleared. When defrost terminates, timing cycles restart.

If thermostat demand is satisfied and a defrost was not initiated during the cycle, compressor run-time will stop (but not reset) when demand is satisfied and continue when a new thermostat demand is received. If the control accumulates a total compressor run-time of six hours, defrost will be initiated.

Cooling Mode Operation

The defrost control uses the liquid line temperature sensor to determine that the control is in cooling mode and defrost is no longer needed. When the liquid line rises above 65°F, the defrost control is turned off and cannot initiate defrost.

TABLE 12

CMC1 DEFROST INITIATION

NOTE-The symbol ΔT (pronounced delta T) is used to represent the difference between liquid line temperature and ambient temperature. The defrost control compares actual ΔT to a calculated ΔT to determine when to initiate defrost.

The defrost control calculates ΔT by inserting the measured ambient temperature into the following equation. You can use the equation to calculate the ΔT for any ambient temperature.

$$\Delta T = 0.30(\text{Ambient Temp.} - 15.0) + 1$$

Once the defrost control has calculated ΔT , it compares the calculated value to the actual measured ΔT . When the actual ΔT exceeds the calculated ΔT , defrost is initiated.

Actual Ambient Temperature (°F)	Calculated ΔT Control will initiate defrost when measured ΔT exceeds this value
35	7
30	5.5
25	4
20	2.5
15	1
10	0
0	0

As long as the liquid line remains above 65°F, the defrost control remains turned off. If, during cooling operation, the liquid line drops below 65°F, the defrost control will initiate timing sequences, monitor liquid line and ambient temperatures and initiate a forced defrost after six hours of compressor run time. If defrost is initiated while the unit is in cooling mode, the outdoor fan will de-energize and the indoor auxiliary heat will energize. A defrost initiated while the unit is in cooling mode is an indicator that the unit may be operating in low ambient conditions or further troubleshooting is required.

Defrost Control Components

1- Defrost LED

An LED on the circuit board lights to indicate the control is in defrost mode.

2- Ambient Temperature Sensor

Ambient sensor (red cable) is permanently attached to the circuit board. The sensing element is attached inside the ambient air port located in lower right corner of compressor compartment (see figure 1).

3- Liquid Line Temperature Sensor

The blue cable is also permanently attached to the circuit board. The sensing element is attached to the liquid line next to the expansion valve.

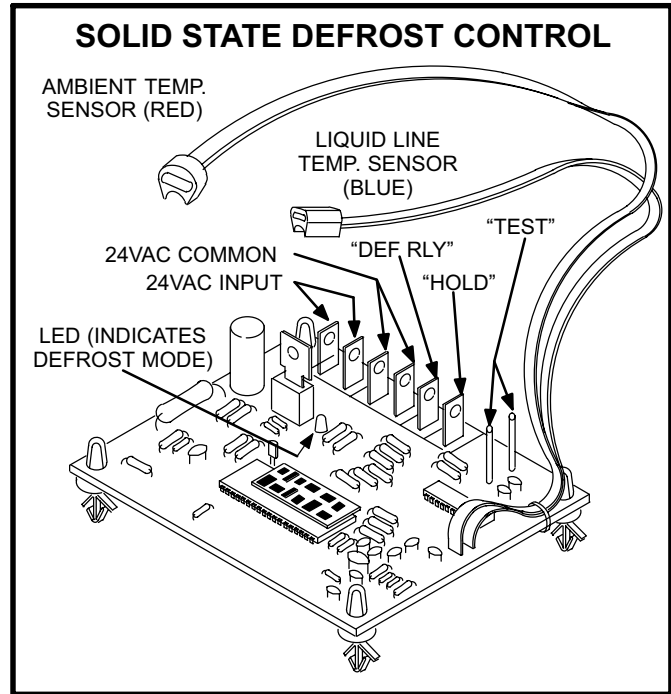

FIGURE 13

4- "24V" Terminal

Terminal "24V" receives 24VAC from the control transformer in the indoor unit (transformer T1 in CB21 series units). This terminal powers the control's internal timer, relays and temperature probes. Terminal "24V" is powered anytime the indoor transformer is powered.

5- "DEF RLY" Terminal

Terminal "DEF RLY" controls defrost when connected in series with defrost relay coil. An internal relay connected to terminal "DEF RLY" closes to allow external defrost relay (K4) to energize and initiate defrost. At the end of defrost period, internal relay connected to terminal "DEF RLY" opens to de-energize external defrost relay.

6- "COM" Terminal

Terminal "COM" provides 24VAC Common.

7- "HLD" Terminal

Terminal "HLD" holds the internal timers in place between thermostat demands and allows the unit to continue timing upon resumption of thermostat demand. Terminal "HLD" is connected directly to 1st stage thermostat demand.

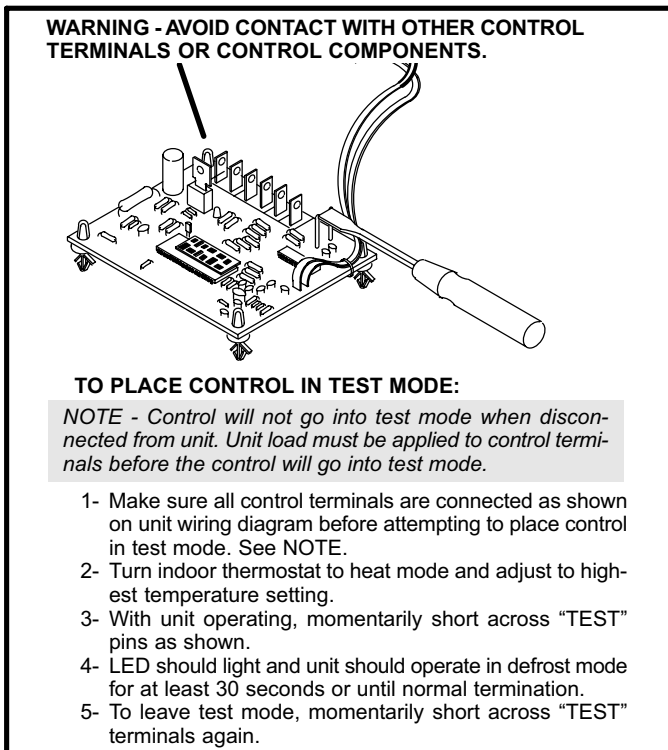

FIGURE 14

8- "TEST" Pins

Each board is equipped with a set of test pins for use in troubleshooting the unit. When momentarily shorted together, these pins initiate a conventional defrost period. Because the defrost period was initiated by momentarily shorting the two "TEST" pins, the defrost period must last a minimum of 30 seconds (see figure 14).

A defrost initiated by shorting the defrost pins together can be terminated by shorting the defrost pins again. Otherwise, defrost will be terminated as in normal operation.

The defrost control continually self-tests its internal circuits. If an internal failure occurs, test mode will not function and defrost LED will not light.

IMPORTANT - CONTROL WILL BEGIN TEST MODE ONLY IF NORMAL LOAD IS APPLIED TO CONTROL TERMINALS. DO NOT ATTEMPT TO OPERATE OR TEST CONTROL OUT OF UNIT.

HP21-3 Units

HP21-3 units are equipped with a demand defrost system which initiates a defrost cycle based on temperature differential and compressor run time. The control board includes two permanently attached sensors which monitor coil and outdoor ambient temperatures. The coil temperature sensor is equipped with a spring clip which allows proper positioning on the outdoor coil return bend. The ambient temperature sensor is installed in a sampling tube at the base of the unit. These sensors must not be detached from the control board and must be replaced as part of the control board. Do not attempt to cut or splice the temperature sensor wires.

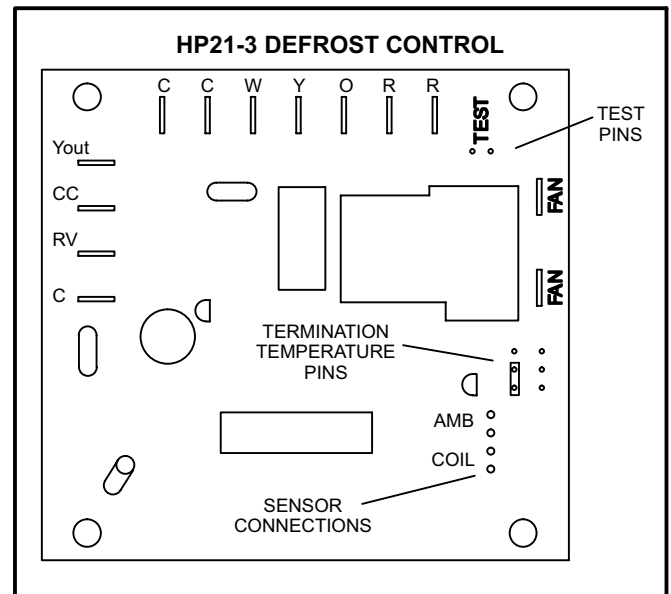

**Figure 15
Operation**

When the reversing valve is de-energized, the Y1 circuit is energized, and the coil temperature is below 35°F (2°C), the board logs the compressor run time. When the unit is initially started and the control is not calibrated, a defrost cycle will be initiated after 34 minutes of heating mode compressor run time. The control will terminate the defrost cycle when the coil temperature rises above the preset termination temperature or after 14 minutes of defrost operation. The termination temperature is factory set at 70°F. This setting may be adjusted in the field to 50°F (10°C), 60°F (16°C), 70°F (21°C), or 80°F (27°C). The control will attempt to self-calibrate after this (and all other) defrost cycle(s). Calibration success depends on stable system temperatures during the 20-minute calibration period. If the board fails to calibrate, another defrost cycle will be initiated after 34 minutes of heating mode compressor run time. Once the defrost board is calibrated, it will use demand defrost logic to initiate a defrost cycle. A demand defrost system initiates defrost when the difference between the clear coil and frosted coil temperatures exceeds the maximum difference allowed by the control.

If the control determines an ambient temperature sensor failure and the coil temperature is 35°F (2°C) or lower, the control will repeatedly initiate a defrost cycle after 34 minutes of heating mode compressor run time. If the control determines that the coil temperature sensor has failed, the control will not initiate a defrost cycle.

Test Mode

When Y1 is energized and 24V power is being applied to the board, a test cycle (approximately 12 seconds) can be initiated by placing the termination temperature jumper across the "Test" pins. If the jumper is applied to the test pins before power is applied, or if the jumper is left across the "Test" pins longer than 5 minutes, the control will ignore the test jumper and will revert to normal operation. The test jumper will initiate continuous defrost cycles until the test jumper is removed or the 5-minute test period ends.

III-REFRIGERANT SYSTEM

A-Field Piping

Field refrigerant piping consists of liquid and vapor lines from the outdoor unit (sweat connections). Use Lennox L10 series line sets as shown in table 13 or field fabricated refrigerant lines. Refer to the piping section of the Lennox Service Unit Information Manual (SUI-803-L9) for proper size, type and application of field-fabricated lines.

TABLE 13

MODEL NO.	LIQUID LINE	VAPOR LINE	L10 LINE SETS
HP21-410 HP21-36	3/8 in.	3/4 in.	L10-41 20 ft. - 50 ft.
HP21-510 HP21-48	3/8 in.	7/8 in.	L10-65 30 ft. - 50 ft.
HP21-650 HP21-60	3/8 in.	1-1/8 in.	FIELD FABRICATED

B-Unit Circuitry

Conventional heat pump circuitry is used. A check valve and expansion valve are used in parallel in the liquid line. The check valve is closed when the unit is in heating mode to force refrigerant through the expansion valve. The check valve is open when the unit is in cooling mode and refrigerant is forced through the drier. Separate discharge and suction service ports are provided at the compressor for connection of gauge manifold during charging procedure. Figures 16 and 18 show HP21 gauge connections.

C-Reversing Valve

HP21 units are equipped with a reversing valve which is used to reverse refrigerant flow. The valve is de-energized during heating mode to direct discharge gas to the indoor coil. The valve is energized during cooling mode and during defrost to direct discharge gas to the outdoor coil. A 24 volt solenoid is used to energize the reversing valve during cooling and defrost demand.

D-Strainer

All units are equipped with a liquid line strainer located adjacent to the expansion valve. The strainer is used to protect the expansion valve from particulate matter entering the system (such as during charging).

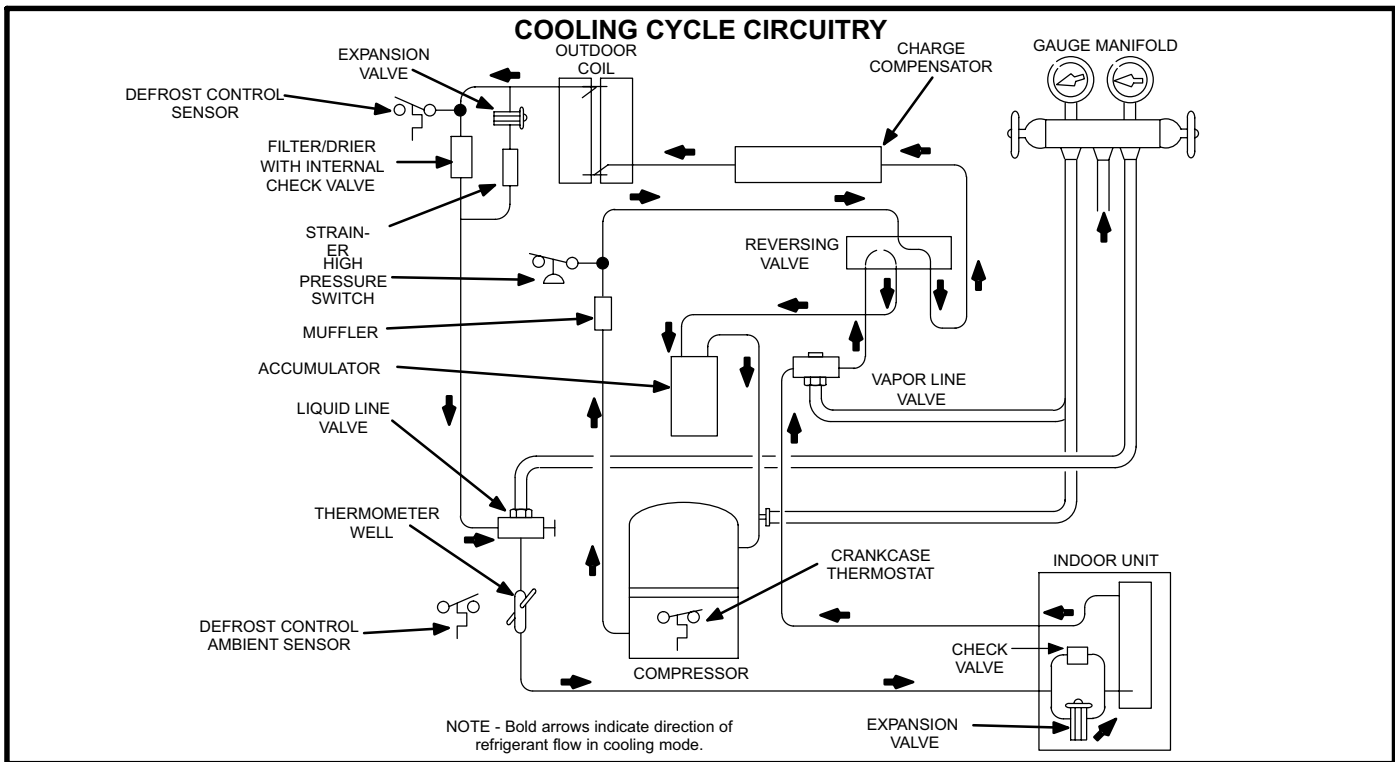

FIGURE 16

E-Filter/Drier

All HP21 units are equipped with a filter/drier located in a circuit parallel to the expansion valve. The filter/drier is equipped with an internal check valve. In heating mode when refrigerant flow is reversed, the check valve is forced closed and refrigerant is routed through the expansion valve. During cooling mode the check valve opens and refrigerant flows freely through the filter/drier. HP21-6 and late model HP21 units will use a Biflow filter /drier.

F-Expansion Valve

All HP21 series units use an externally equalized thermal expansion valve as the primary expansion device in the outdoor unit. The expansion valve is factory set, non-adjustable and non-serviceable. HP21-6 and late model HP21 units will use an expansion valve with internal check valve to pair with the biflow filter drier.

G-Discharge Muffler

All units are equipped with a discharge muffler connected between the compressor discharge port and the reversing valve. The discharge muffler is located immediately in front of the compressor in the compressor compartment. See figure 19.

H-Accumulator

All units are equipped with a suction line accumulator connected between the reversing valve and the compressor suction port. The accumulator is located immediately behind the compressor in the compressor compartment. See figure 19.

The accumulator can be accessed without removing the compressor. To access the accumulator, remove the outdoor fan guard. Then remove the fan motor and bracket as an assembly. By reaching inside the fan opening, remove all screws securing the compressor wrapper to the unit (see figure 17). Then hinge the wrapper up out of the way to access the accumulator.

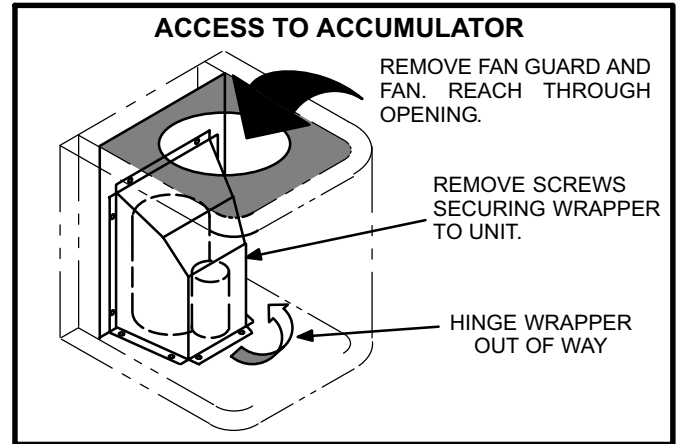

FIGURE 17

I-Thermometer Well

Early model units only are equipped with a thermometer well for use in measuring liquid line temperature when charging the unit. The thermometer well is used in all Lennox recommended charging procedures. It is located in the liquid line adjacent to the liquid line service valve.

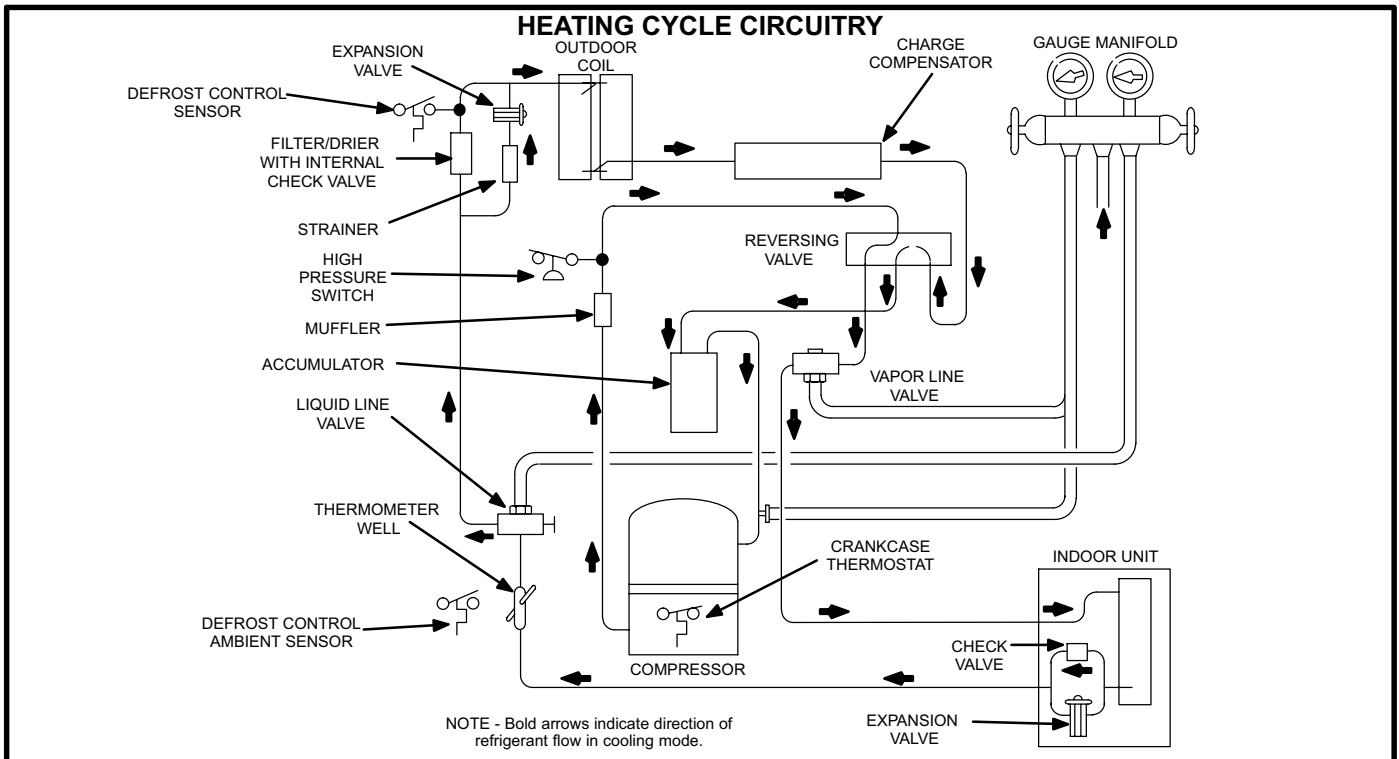

FIGURE 18

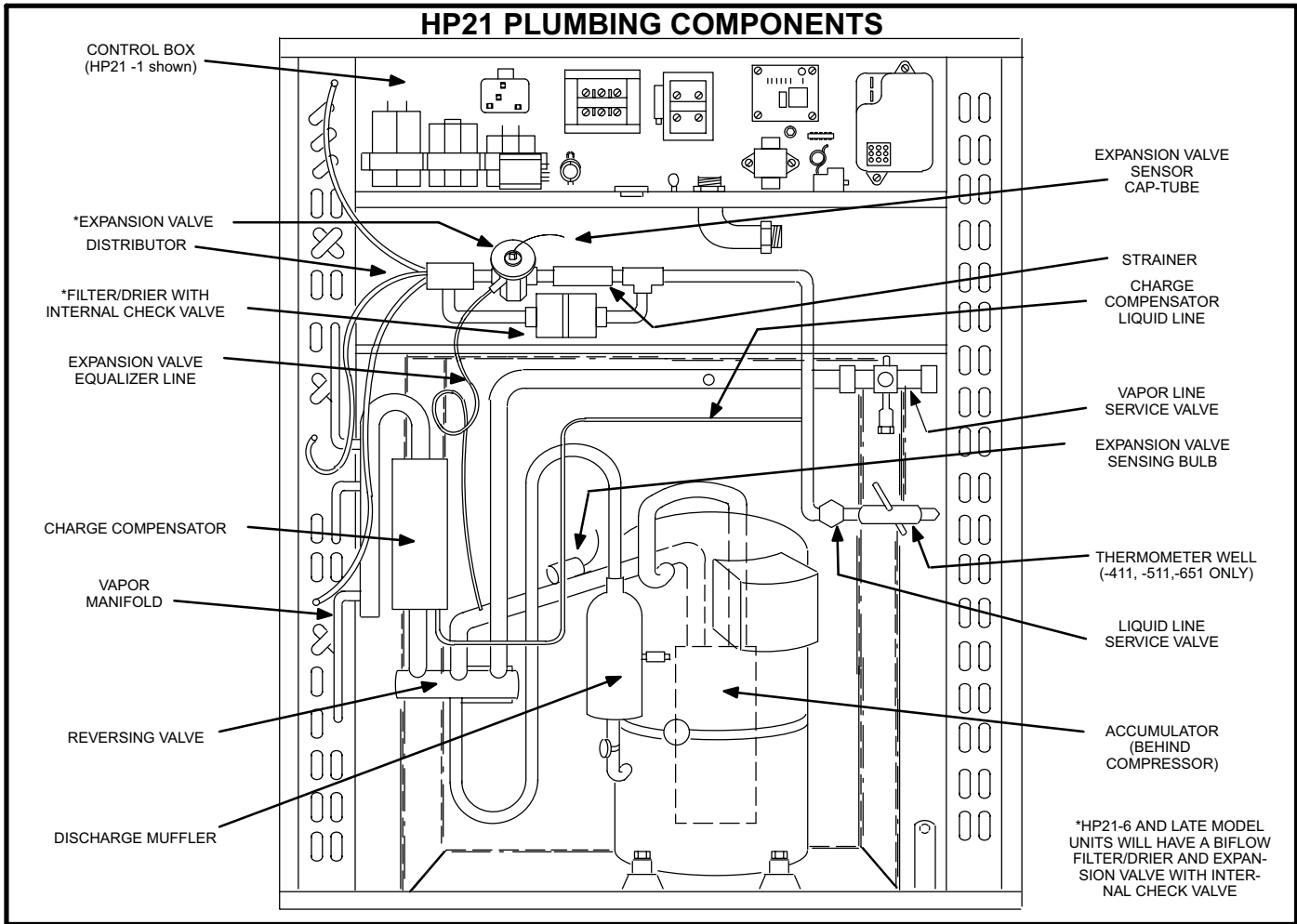

FIGURE 19

J-Charge Compensator

HP21-410, -650, -36 and -60 series units are equipped with a charge compensator located in the vapor line between the reversing valve and outdoor coil manifold. Figure 19 shows the relative location of the charge compensator in the unit. The compensator is used to collect and store excess refrigerant in the heating mode. Figure 20 shows operation of the charge compensator.

The charging procedure for these units is unchanged. Follow the charging procedure outlined in the installation instructions or in the Unit Information Manual.

In heating mode, the vapor line passing through the charge compensator tank is cooler than the liquid line. Excess refrigerant (condensed liquid) from the indoor coil is trapped by the compensator. The vapor is cooler than the liquid line so liquid migrates from the liquid line to the compensator tank where it is stored. In cooling mode, the vapor line passing through the charge compensator tank is hotter than the liquid line. Stored liquid is boiled and forced back into the liquid line for circulation.

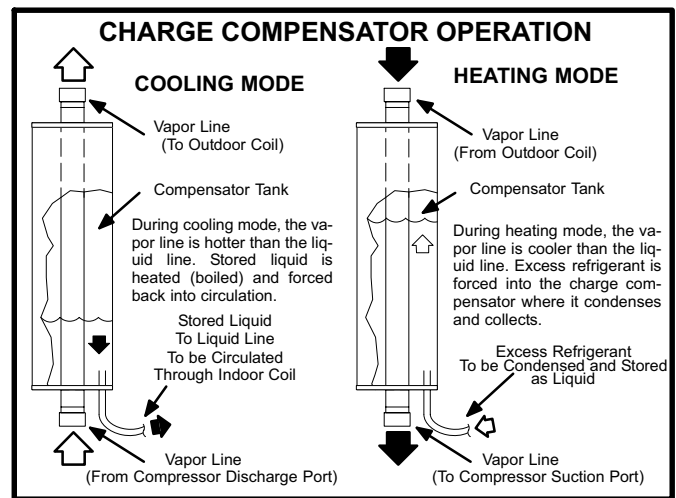

FIGURE 20

K-Service Valves

The liquid line and vapor line service valves and gauge ports are accessible on the inside of the unit by removing the compressor access panel. The “one shot” vapor line service valve (figure 21) cannot be closed once it has been opened. Both service valves are equipped with gauge ports which can be used for leak testing, evacuating, charging and checking charge. A separate gauge port is provided for checking the suction pressure when the unit is in the heating cycle.

CAUTION-When sweating any valve, always wrap a wet rag around the valve and adjoining pipe. Cool joint with wet rag after brazing.

WARNING-The liquid line valve is not a back-seating valve (has valve core in service port) and it should not be opened more than 5 turns. Opening or closing the valve does not close the service port.

To operate the valve, fully insert hex wrench into the stem and **BACK OUT COUNTER-CLOCKWISE UNTIL THE STEM JUST TOUCHES THE RETAINING RING.**

If visual verification of the valve stem reaching the retaining ring is impossible, **STOP BACKING-OUT THE VALVE STEM WHEN THE SLIGHTEST RESISTANCE IS FELT.**

Because of the small size and therefore the reduced resistance, **BACK-OUT THE LIQUID VALVE 5 TURNS MAXIMUM** to prevent going past the retaining ring.

If the valve stem is backed-out past the retaining ring, the O-ring can be damaged causing leakage or system pressure could force the valve stem out of the valve body possibly causing personal injury. In the event the retaining ring is missing, do not attempt to open the valve.

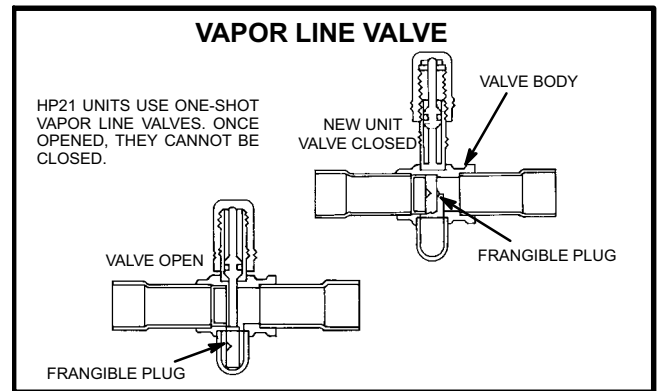

FIGURE 21

After servicing unit, replace valve cap finger tight, then tighten an additional 1/2 turn (1/2 hex flat). Cap must be replaced to prevent leaks.

L-Low Ambient Control Kit (Optional)

The HP21 unit will operate satisfactorily down to 45°F (7°C) outdoor air temperature without any additional controls. For cases where operation of the unit is required at low ambients, a Low Ambient Control Kit LB-57113BM (27J00) can be added in the field, enabling the unit to operate properly down to 30°F (-1°C). Included in the kit are the low ambient relay (K58) and the low pressure switch (S11).

IV-CHARGING

The unit is factory-charged with the amount of R-22 refrigerant indicated on the unit rating plate. This charge, as shown in figure 14, is based on a matching indoor coil and outdoor coil with 15 feet of line set.

TABLE 14

Model	Refrigerant Charge R-22
HP21-410, -36	13 lbs. 8 oz.
HP21-510, -48	15 lbs. 8 oz.
HP21-650, -60	19 lbs. 2 oz.

For varying lengths of line set, refer to table 15 for refrigerant charge adjustment. A blank space is provided on the unit rating plate to list actual field charge.

TABLE 15

LINE SET DIAMETER		Ounces per foot adjust from 15 ft. line set*
Vapor	Liquid	
3/4 in. (19mm)	3/8 in. (10mm)	1/2 ounce (15ml)
7/8 in. (22mm)	3/8 in. (10mm)	3/4 ounce (21ml)
1-1/8 in. (29mm)	3/8 in. (10mm)	3/4 ounce (21ml)

* If line length is greater than 15 feet, add this amount. If line length is less than 15 feet, subtract this amount.

A-Leak Testing

- 1- Attach gauge manifold and connect a drum of dry nitrogen to center port of gauge manifold.

CAUTION-WHEN USING DRY NITROGEN, A PRESSURE REDUCING REGULATOR MUST BE USED TO PREVENT EXCESSIVE PRESSURE IN GAUGE MANIFOLD, CONNECTING HOSES, AND WITHIN THE SYSTEM. REGULATOR SETTING MUST NOT EXCEED 150 PSIG (1034 KPA).

- 2- Open high pressure valve on gauge manifold and pressurize line set and indoor coil to 150 psig.
- 3- Check lines and connections for leaks.

NOTE-If electronic leak detector is used, add a trace of refrigerant to the nitrogen for detection by the leak detector.

- 4- Release nitrogen pressure from the system, correct any leaks and recheck.

B-Evacuating and Dehydrating the System

- 1- Attach gauge manifold as shown in figure 16. Connect vacuum pump (with vacuum gauge) to center port of gauge manifold. With both manifold service valves open, start pump and evacuate indoor coil and refrigerant lines.

NOTE-A temperature vacuum gauge, mercury vacuum (U-tube), or thermocouple gauge should be used. The usual Bourbon tube gauges are not accurate enough in the vacuum range.

- 2- Evacuate the system to 29 inches vacuum. During the early stages of evacuation, it is desirable to stop the vacuum pump at least once to determine if there is a rapid loss of vacuum. A rapid loss of vacuum would indicate a leak in the system and a repeat of the leak testing section would be necessary.
- 3- After system has been evacuated to 29 inches (737mm), close gauge manifold valves to center port, stop vacuum pump and disconnect from gauge manifold. Attach an upright nitrogen drum to center port of gauge manifold and open drum valve slightly to purge line at manifold. Break vacuum in system with nitrogen pressure by opening manifold high pressure valve. Close manifold high pressure valve to center port.
- 4- Close nitrogen drum valve and disconnect from gauge manifold center port. Release nitrogen pressure from system.
- 5- Reconnect vacuum pump to gauge manifold center port. Evacuate system through manifold service valves until vacuum in system does not rise above 29.7 inches (754mm) mercury (5mm absolute pressure) within a 20-minute period after stopping vacuum pump.
- 6- After evacuation is complete, close manifold center port, and connect refrigerant drum. Pressurize system slightly with refrigerant to break vacuum.

C-Charging

The system should be charged in the cooling cycle if weather conditions permit. The following procedures are intended as a general guide and slight variations in temperature and pressure should be expected. Large variations may indicate a need for further servicing.

If the system is completely void of refrigerant, the recommended and most accurate method of charging is to weigh the refrigerant into the unit according to the total amount shown on the unit nameplate and in table 14. Refer to the Lennox Unit Information Service manual for proper procedure.

If weighing facilities are not available or if unit is just low on charge, the following procedures apply.

BEFORE CHARGING (steps 1 through 4)

NOTE - The following procedures require accurate readings of ambient temperature, liquid temperature and liquid pressure for proper charging. Use a thermometer with accuracy of $\pm 2^{\circ}\text{F}$ and a pressure gauge with accuracy of $\pm 5\text{PSIG}$.

- 1- Connect gauge manifold as shown in figure 16. Connect an upright R-22 drum to center port of gauge manifold.
- 2- Record outdoor ambient temperature.
- 3- If indoor temperature is below 74°F, set room thermostat to 74°F (23°C) in “Emergency Heat” or “Heat” position and allow unit to run until heating demand is satisfied. This will create the necessary load for proper charging of system in cooling cycle. Change thermostat setting to 68°F (20°C) in “Cool” position. Allow unit to run until system pressures stabilize.
- 4- Make sure thermometer well is filled with mineral oil before checking liquid line temperature.

NOTE-When checking or adjusting charge, compressor should always be on high speed and indoor blower should be on cooling high speed. For cooling mode, set room thermostat at lowest setting. For heating mode, place a jumper across speed control thermostat (S6) in outdoor unit and then reset the room thermostat to OFF and back to HEAT.

OUTDOOR TEMPERATURE ABOVE 60°F (step 5)

- 5- If ambient temperature is above 60°F, system should be charged using the approach method. Place thermometer in well and read liquid line temperature. The difference between liquid line temperature and ambi-

ent temperature is the approach temperature. Approach temperature should match the values shown in table 16. Add refrigerant to reduce approach temperature and remove refrigerant to increase approach temperature.

TABLE 16

Model	Liquid Temp Minus Ambient Temp. (°F)
HP21-411/413, HP21-36-230/233	9 ± 2
HP21-511/513, HP21-48-230/233	7 ± 2
HP21-651/653, HP21-60-230/233	10 ± 2

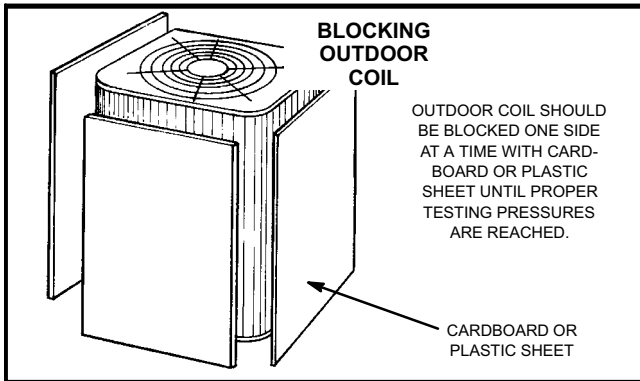

FIGURE 22

OUTDOOR TEMPERATURE BELOW 60°F (steps 6 through 8)

- It is not recommended that the system be charged below 60°F. If charging below 60°F is required, the most reliable method is to weigh in the charge listed on the unit nameplate. This amount (table 14) will be correct for a system with a line set of 25 feet. If line set is longer or shorter than 25 feet, add or remove refrigerant as shown in table 15.
- If ambient temperature is less than 60°F (10°C), system should be charged using the subcooling method. Air flow will need to be restricted to achieve pressures in the 200-250 psig range (See figure 22.) These higher pressures are necessary for checking the subcooling temperature. Block equal sections of air intake panels, moving obstructions sideways as shown until liquid pressure rises above 200 psig.
- Read liquid line pressure from gauge and convert to condensing temperature using standard R-22 temperature/pressure conversion chart (or conversion scale on gauge.) The difference between the liquid line temperature and the conversion temperature is subcooling (subcooling = conversion temperature minus liquid line temperature). The subcooling temperature should approximate the values given in table 17. Add refrigerant to increase subcooling and remove refrigerant to reduce subcooling.

TABLE 17

Model	Subcooling °F
HP21-410/510/650/36/48/60	10 ± 3

ALL UNITS (step 9)

- When unit is properly charged, liquid line pressures should approximate those given in table 18.

D-Oil Charge

Factory oil charge in all HP21 series units is 70 fl. oz. Replacement oil charge is 66 fl.oz.

TABLE 18

NORMAL OPERATING PRESSURES							
MODE	OUTDOOR COIL ENTERING AIR TEMP.	HP21-411 HP21-413 HP21-36-230 HP21-36-233		HP21-511 HP21-513 HP21-48-233 HP21-48-230		HP21-651 HP21-653 HP21-36-230 HP21-36-233	
		LIQ. ± 10 PSIG	SUC. ± 5 PSIG	LIQ. ± 10 PSIG	SUC. ± 5 PSIG	LIQ. ± 10 PSIG	SUC. ± 5 PSIG
COOLING EXPANSION VALVE ONLY	75 °F	175	74	177	80	182	76
	85 °F	208	76	190	84	213	79
	95 °F	245	78	228	86	242	80
	105 °F	277	80	266	88	276	82
HEATING ALL UNITS	20 °F	180	33	160	32	175	31
	30 °F	191	40	171	40	185	38
	40 °F	206	49	184	50	206	47
	50 °F	225	59	204	62	227	57

NOTE - Liquid line pressure in heating mode may vary more than ±10 PSIG depending on unit matchup. All pressures are with unit operating on high speed. Indoor return air 80°F for cooling.

V-Maintenance

At the beginning of each heating or cooling season, the system should be cleaned as follows:

A-Heat Pump Unit

- Clean and inspect outdoor coil. (Coil may be flushed with a water hose.)
- Rotate fan to check for frozen bearings or binding. Outdoor fan motor is prelubricated and sealed with plugs. No further lubrication is required.
- Visually inspect all connecting lines, joints and coils for evidence of oil leaks.
- Check all factory and field-installed wiring for loose connections.
- Check voltage supply at disconnect (unit not operating.) Voltage must be within range listed on unit rating plate. If not, do not start equipment until the power company has been consulted and the voltage condition corrected. Check for correct voltage at unit (unit operating).
- Check fan motor amp-draw. Unit nameplate _____ Actual _____.
- Check compressor amp-draw. Unit nameplate _____ Actual _____.

NOTE - If insufficient heating or cooling occurs, the unit should be gauged and refrigerant charge checked.

B-Indoor Coil

- 1- Clean or change filters.
- 2- Check connecting lines, joints and coil for evidence of oil leaks.
- 3- Check condensate line and clean if necessary.

C-Indoor Unit

- 1- Clean or change filters.
- 2- Inspect coil. Clean if necessary.
- 3- Rotate blower wheel to check for binding bearings. Lennox blower motors are prelubricated and sealed. No further lubrication is required.
- 4- Adjust blower speed for cooling. The static pressure drop over the coil should be checked to determine the correct blower CFM. Refer to Lennox Engineering Handbook for Static Pressure and CFM tables.
- 5- Check all factory and field-wiring for loose connections.
- 6- Check for correct voltage at unit.
- 7- Check amp-draw on blower motor (does not apply to CB21.)
Unit nameplate _____ Actual _____.

VI-Miscellaneous

If the fan orifice should ever need to be removed for service, make sure the control box seals watertight before placing the unit back in service. Figure 23 shows the components used to make the control box watertight. Two screws securing the top of the control box to the cabinet must have rubber washers installed. Also, the control box must be installed with a foam-rubber weatherstrip installed along the top edge (between the control box and the cabinet).

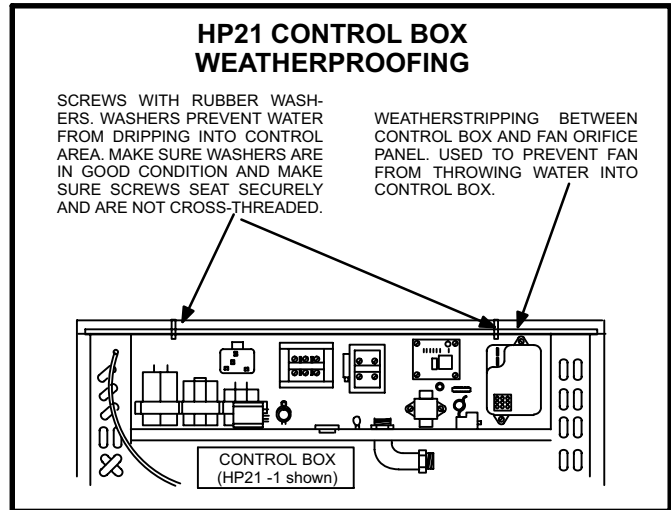

**FIGURE
23**

VII-WIRING DIAGRAMS AND OPERATION SEQUENCE

A-Field Wiring

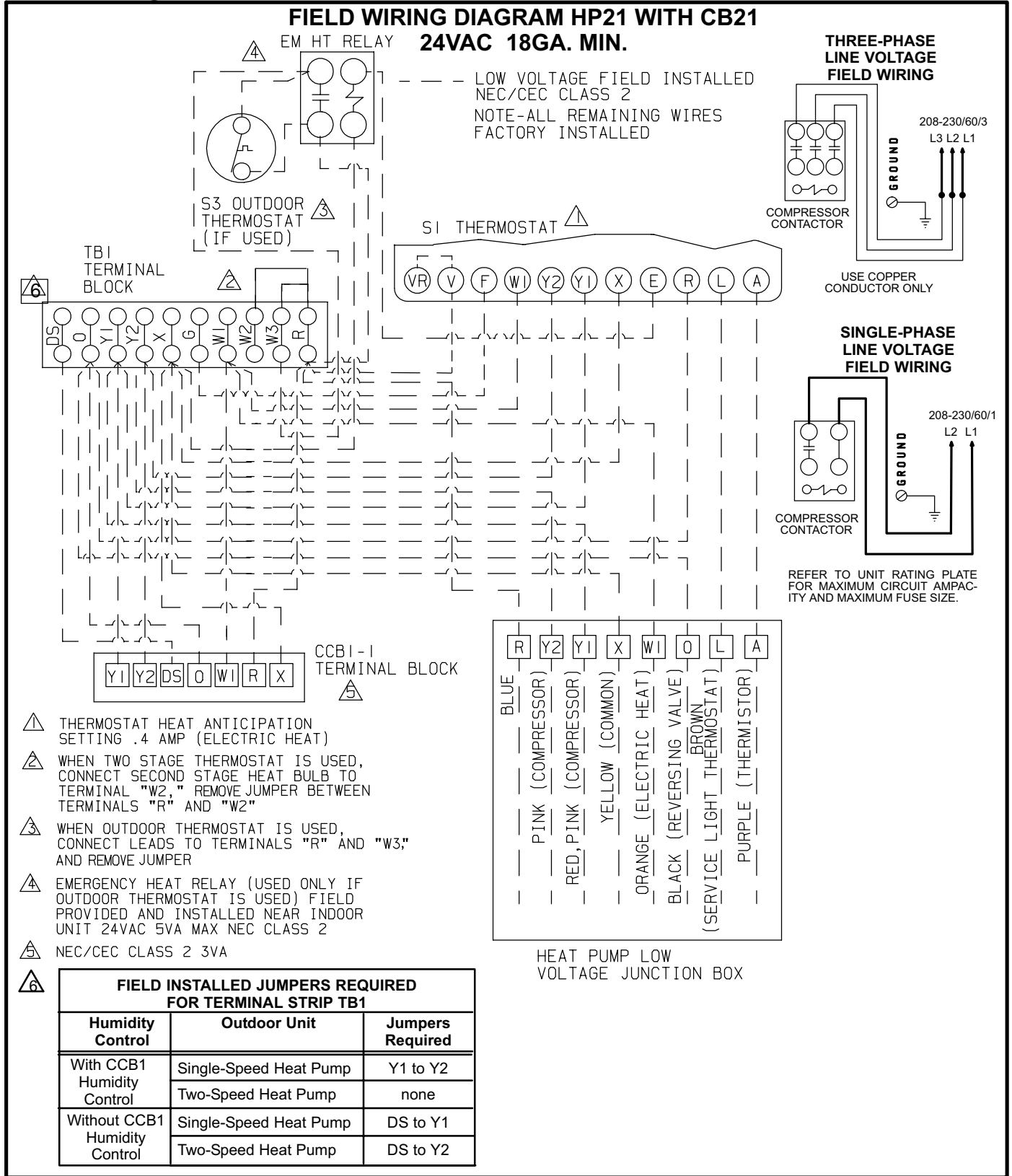

FIGURE 24

FIELD WIRING DIAGRAM HP21 WITH CB31MV

CLASS 2 VOLTAGE FIELD INSTALLED
 NEC/CEC
 NOTE-ALL REMAINING WIRES
 FACTORY INSTALLED

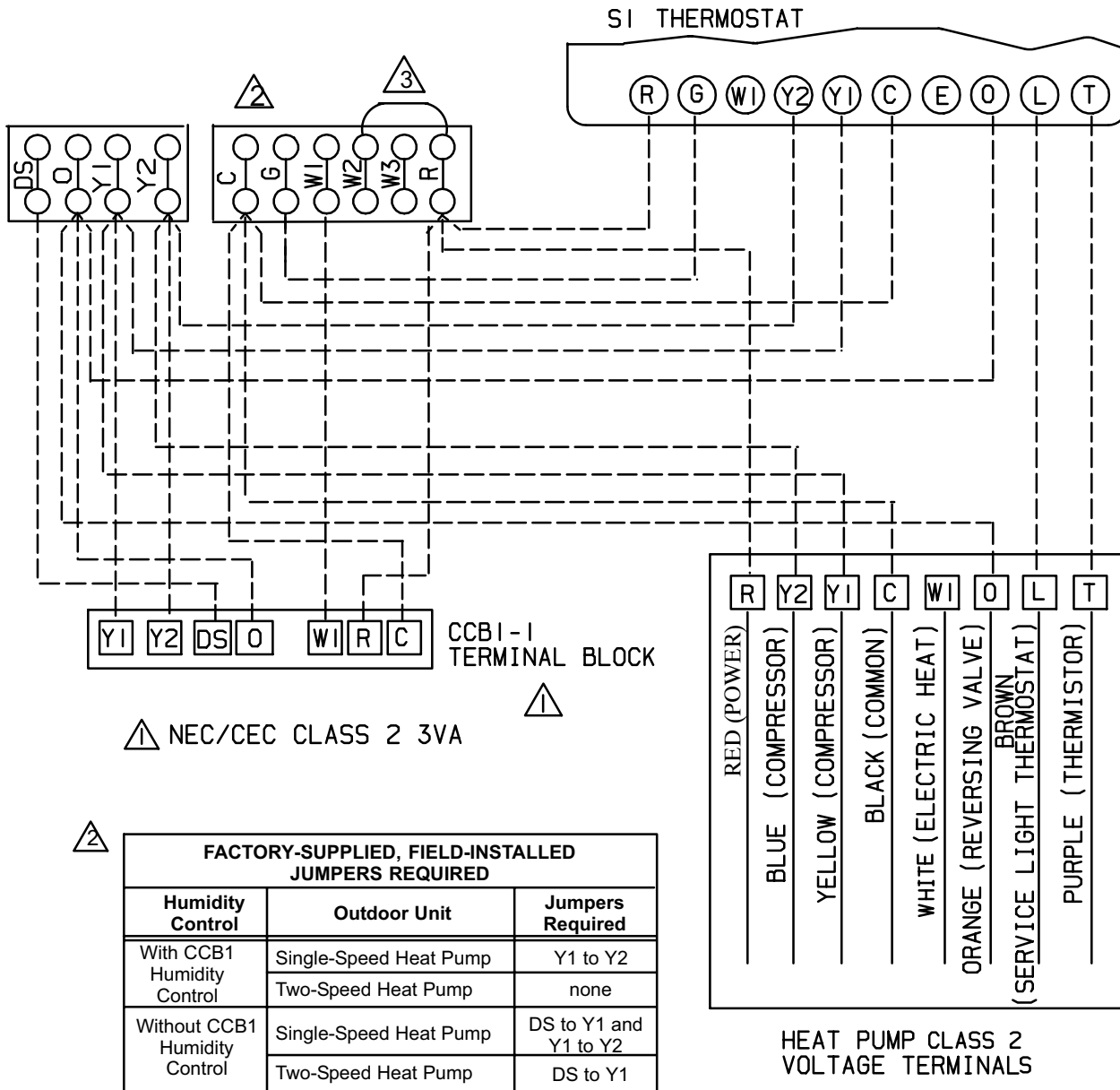

FIGURE 25

B-Operation Sequence - Compressor

Single-Phase Compressor Startup

Figure 26 shows single-phase compressor windings. This compressor has a two speed capacitor-start, capacitor-run motor. For starting, the start and run capacitors are in parallel to provide the proper starting torque. The start capacitor is disconnected by the start relay when the compressor comes up to speed. The run capacitor remains connected to the start winding and the motor runs as a two-phase induction motor with improved power factor and torque characteristics provided by the capacitor.

Low speed compressor operation is provided by powering the run windings (internally connected in series) from terminals 1 (common) and 7. The windings form a four-pole motor operating at 1800 RPM. The four low speed start windings are in series and are connected to terminals 1 (common) and 8. They are used with the start and run capacitors and start relay to start and bring the motor up to speed.

High speed compressor operation is provided when the run windings are connected in parallel; terminals 1 (common) and 7 to L1 and terminal 2 to L2. The windings form a two-pole motor operating at 3600 RPM. The two high speed start windings are in series and connected to terminals 1 (common) and 3.

Three Phase Compressor Startup

Figure 27 shows the windings of three-phase two-speed compressors. The compressors have two-speed, three-phase induction motors. Capacitors are not needed to provide the proper phase and torque characteristics.

Low speed operation is provided when the motor windings are connected in a series "Delta" circuit. The motor operates at 1800 RPM.

High speed operation is provided when the motor windings are connected in a parallel "Delta" circuit. Normally closed contacts on the low speed contactor provide this connection.

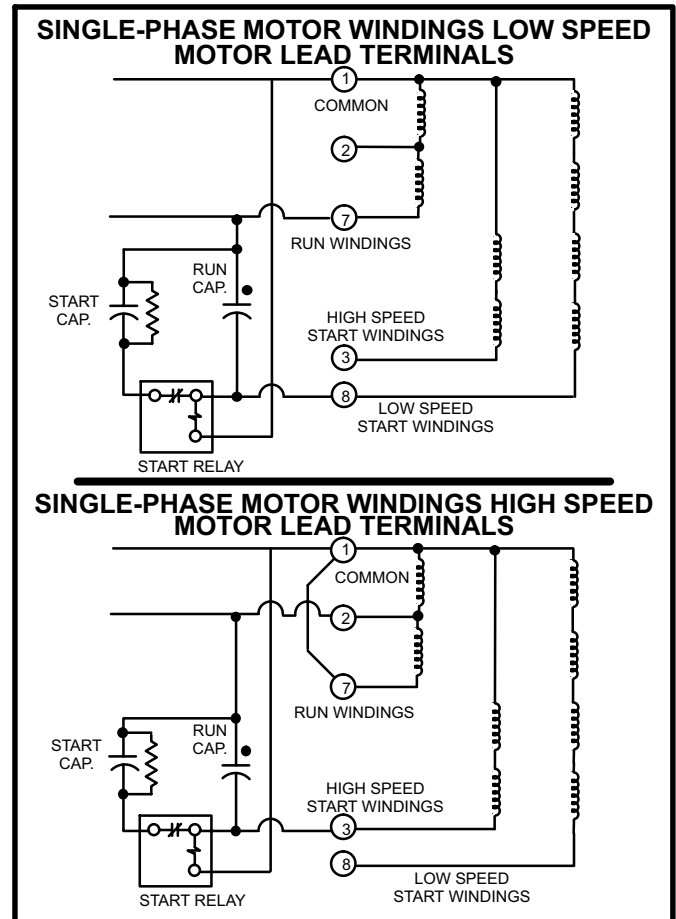

FIGURE 26

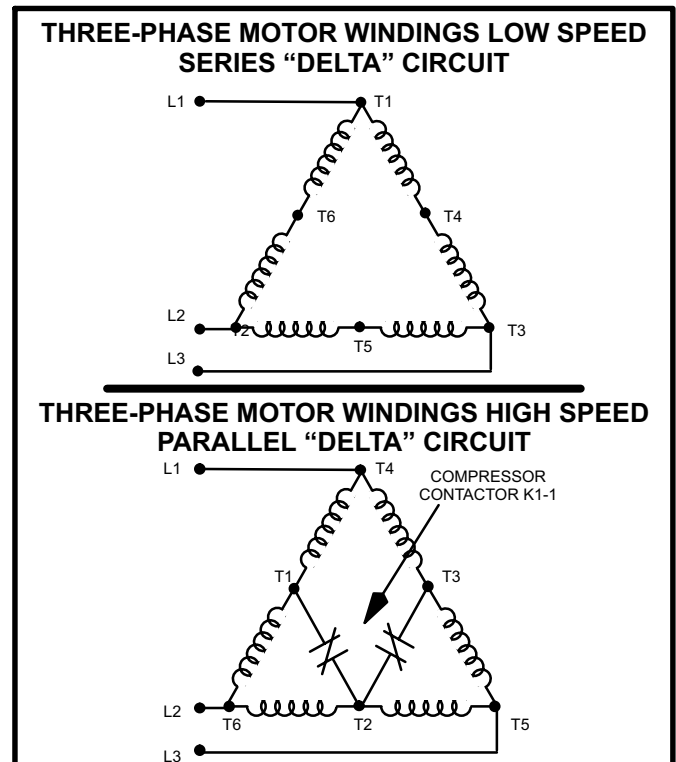

FIGURE 27

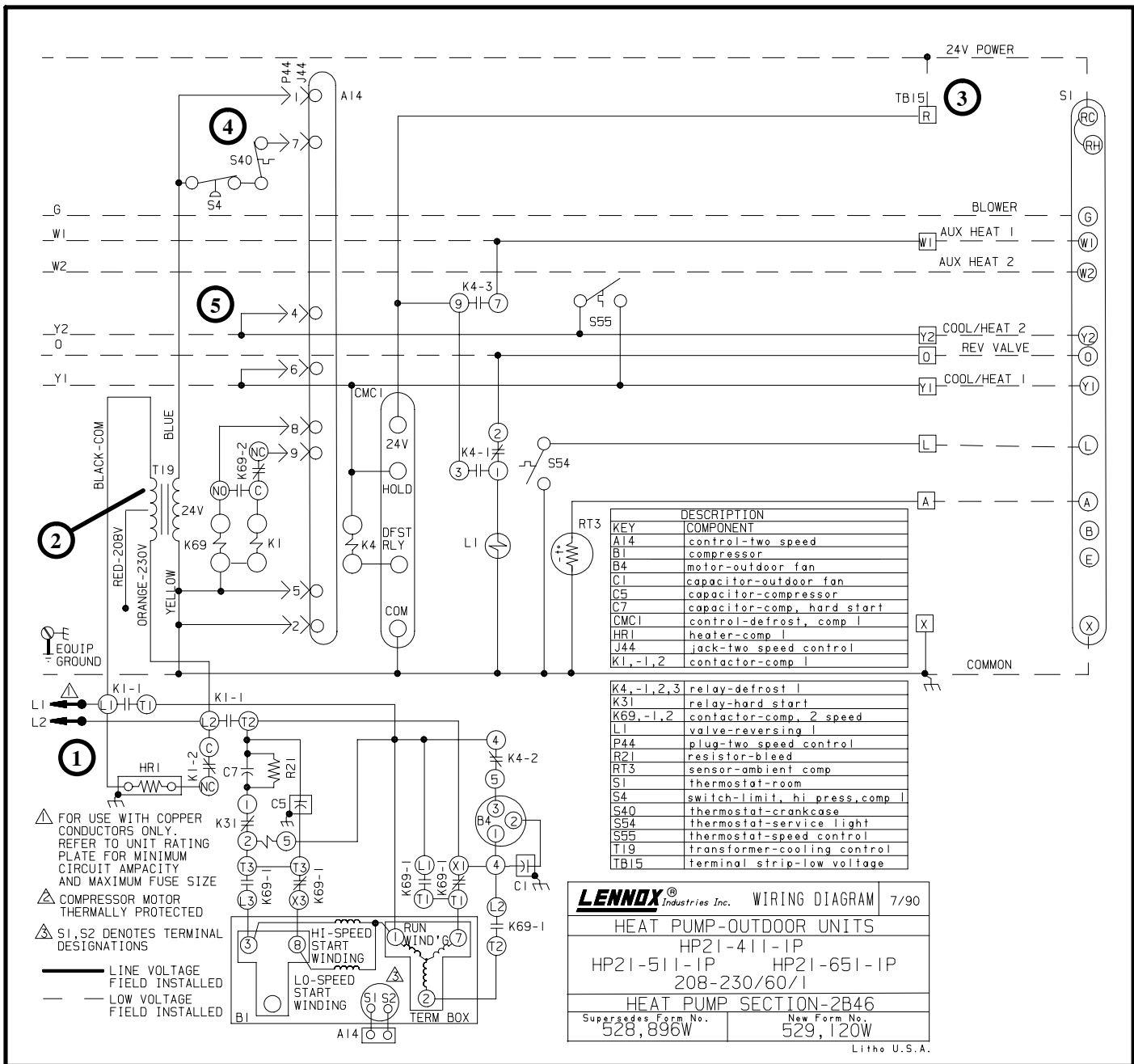

FIGURE 28

C-SINGLE-PHASE STARTING SEQUENCE

- 1-Line voltage feeds through L1 and L2 to energize outdoor transformer T19 and outdoor unit. Crankcase heater is energized through relay K1 auxiliary contacts.
- 2-Transformer T19 provides 24VAC to TSC and contactors K1 and K69.
- 3-The indoor transformer supplies 24VAC to the indoor unit and the indoor thermostat. Indoor transformer also provides 24VAC power to

defrost control CMC1, reversing valve L1, speed control thermostat S55, service light thermostat S54 and ambient thermistor RT3 in outdoor unit.

- 4-On power-up, 24VAC is fed through JP44-1 and JP44-7 to the TSC. The TSC begins a 10 second power-up delay.
- 5-The TSC begins a 5 minute delay during which the outdoor unit is not operational. After the 5 minute delay, the TSC waits in "OFF" mode for 1st stage or 2nd stage demand.

D-SINGLE-PHASE COMPRESSOR STARTUP

LOW SPEED

- 1- 1st stage demand: If all safety circuits check out, TSC energizes JP44-9.
- 2- Contactor K1 is energized through K69-2 N.C. contacts. K1-2 contacts open to de-energize the crankcase heater. All other K1 contacts close to start outdoor fan operation and to begin compressor low speed start-up.
- 3- Compressor B1 terminal 1 and the outdoor fan circuit are energized by K1 contacts L1-T1. Compressor terminal 7 is energized by contactor K1 terminal L2-T2 through contactor K69 terminal T1-X1. Compressor terminal 8 (start winding) is energized by contactor K1 terminal L2-T2 through the start (C7) and run (C5) capacitors and contactor K69 terminal T3-X3.
- 4- Outdoor fan B4 is energized through relay K4-2 when contactor K1 contacts L1-T1 and L2-T2 close.
- 5- As the compressor nears full speed, potential relay K31 energizes and K31 contacts open to de-energize the start capacitor.

HIGH SPEED

- 6- 2nd stage demand: If all safety circuits check out, TSC energizes JP44-8.
- 7- Contactor K69 energizes and K69-2 auxiliary contacts close to energize contactor K1. K1-2 auxiliary contacts open to de-energize the crankcase heater. All other K1 contacts close. K1 contacts L1-T1, L2-T2 and L3-T3 close while contacts T1-X1 and T3-X3 open.
- 8- Compressor B1 terminal 3 (start winding) is energized by contactor K1 terminal L2-T2 through the start (C7) and the run (C5) capacitors and through contactor K69 terminal L3-T3. Compressor terminal 2 is energized by contactor K1 terminal L2-T2. Compressor terminal 1 is energized directly by contactor K1 terminal L1-T1. Compressor terminal 7 is energized by contactor K1 terminal L1-T1 through contactor K69 terminal L1-T1.
- 9- Outdoor fan B4 is energized through relay K4-2 when contactor K1 contacts L1-T1 and L2-T2 close.
- 10- As the compressor nears full speed, potential relay K31 energizes and K31 contacts open to de-energize start capacitor C7.

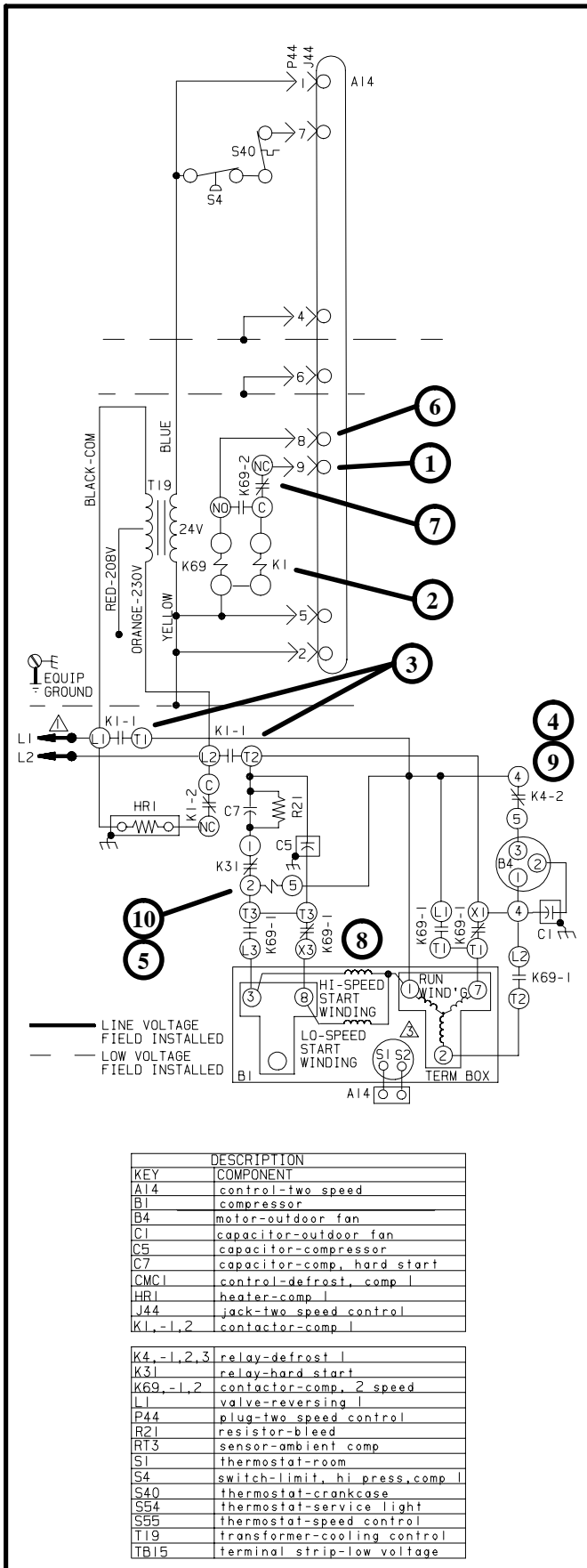

FIGURE 29

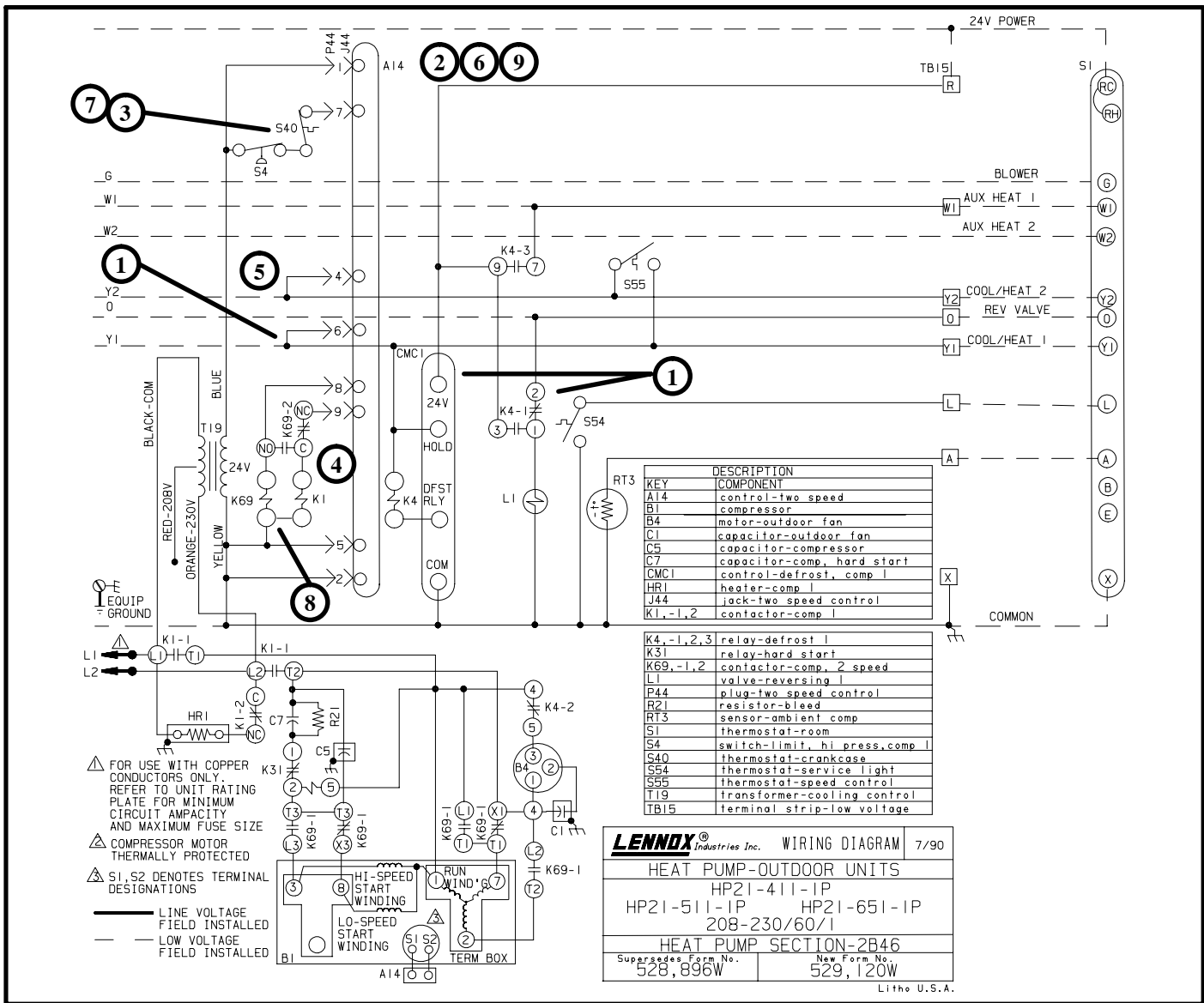

FIGURE 30

E-SINGLE-PHASE COOLING SEQUENCE

1- 1st stage cooling demand energizes TB15-Y1 and TB15-O. TB15-O energizes reversing valve L1. TB15-Y1 energizes TSC terminal JP44-6 and defrost control terminal HOLD. Defrost control begins initial timing sequence.

NOTE-2nd stage cooling demand may be energized directly without passing through 1st stage.

- 2- TSC delays 3 seconds before responding to the new command.
- 3- If the unit is changing from 2nd stage to 1st stage demand, TSC initiates speed change delay and de-energizes JP44-8 and JP44-9 to stop all unit operation for 60±5 seconds. After TSC completes the 60±5 second speed change delay or if the unit is starting-up in 1st stage directly from OFF mode, TSC checks safety circuits by looking for 24VAC at JP44-7 and by checking resistance through wires connected to S1 and S2.
- 4- If all safety circuits check-out, TSC energizes K1 and compressor begins low speed startup.

- 5- 2nd stage cooling demand energizes TB15-Y1, TB15-Y2 and TB15-O. TB15-O energizes TSC terminal JP44-4. TB15-O energizes TSC terminal JP44-6 and defrost control terminal HOLD.

- 6- TSC delays 3 seconds before responding.
- 7- If the unit is changing from 1st stage to 2nd stage demand, the TSC initiates speed change delay and de-energizes JP44-8 and JP44-9 to stop all unit operation for 60±5 seconds. After TSC completes the 60±5 second speed change delay or if the unit is starting-up in 2nd stage directly from OFF mode, TSC checks safety circuits by looking for 24VAC at JP44-7 and by checking resistance through wires connected to S1 and S2.
- 8- If all safety circuits check-out, TSC energizes K1 and K69. Compressor begins high speed startup.
- 9- When thermostat demand is satisfied or if thermostat is switched OFF or switched to heating mode, all outdoor unit operation stops after a delay of 3 seconds. TSC then completely resets (erase accumulated faults) before beginning a 5 minute timed-off delay.

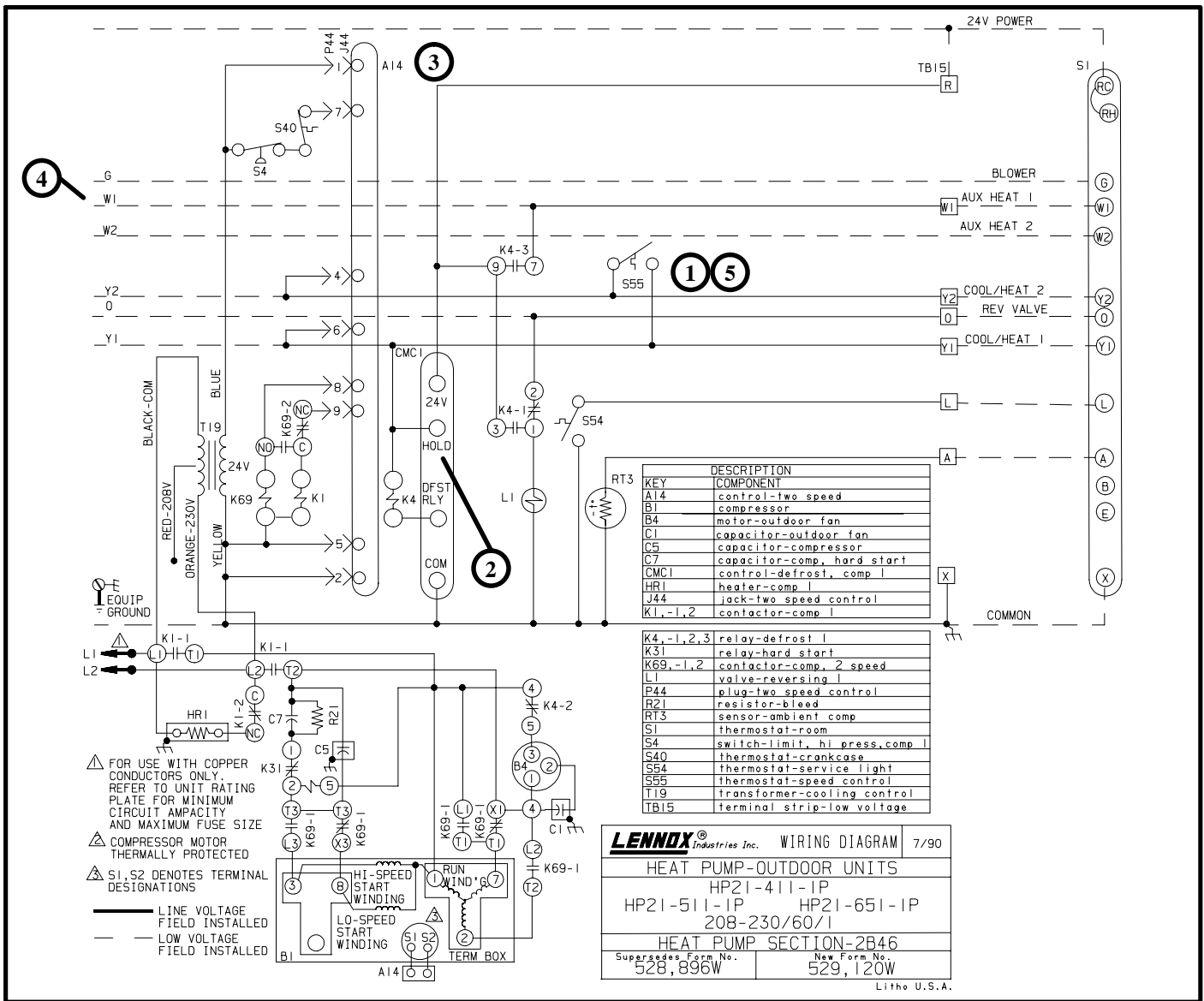

FIGURE 31

F-SINGLE-PHASE HEATING SEQUENCE

- 1-Speed control thermostat S55 determines whether the compressor is to operate on high or low speed based on outdoor temperature. If outdoor temperature drops below set temperature, S55 closes to shunt across Y2. When Y2 is shunted, a 2nd stage demand is sent to the two speed control and the compressor runs on high speed. If outdoor temperature rises above set temperature, S55 opens and the compressor runs on low speed.
- 2-1st stage demand energizes TB15-Y1. TB15-Y1 energizes TSC, speed control thermostat S55 and defrost control terminal HOLD. Defrost control initializes timing sequence.
NOTE-2nd stage heating demand may be energized directly without passing through 1st stage.
- 3-TSC delays 3 seconds before responding to the new command. Then

- compressor begins operating at low or high speed as determined by speed control thermostat S55.
- 4-2nd stage heating demand energizes TB15-Y1 and TB15-W1. TB15-Y1 energizes TSC, speed control thermostat S55 and defrost control terminal HOLD. The compressor continues to operate at low or high speed as determined by speed control thermostat S55. TB15-W1 energizes the indoor auxiliary heat relay for 2nd stage heat.
- 5-Speed control thermostat can open or close during 1st stage or 2nd stage heating operation. When S55 opens, the compressor runs on low speed. When S55 closes, the compressor runs on high speed. If speed control thermostat S55 opens or closes during compressor operation, TSC initiates speed change delay and stops all unit operation for 60±5 seconds (indoor unit continues to operate and if 2nd stage thermostat demand is present auxiliary heat continues operate). If all safety circuits check-out, TSC energizes compressor.

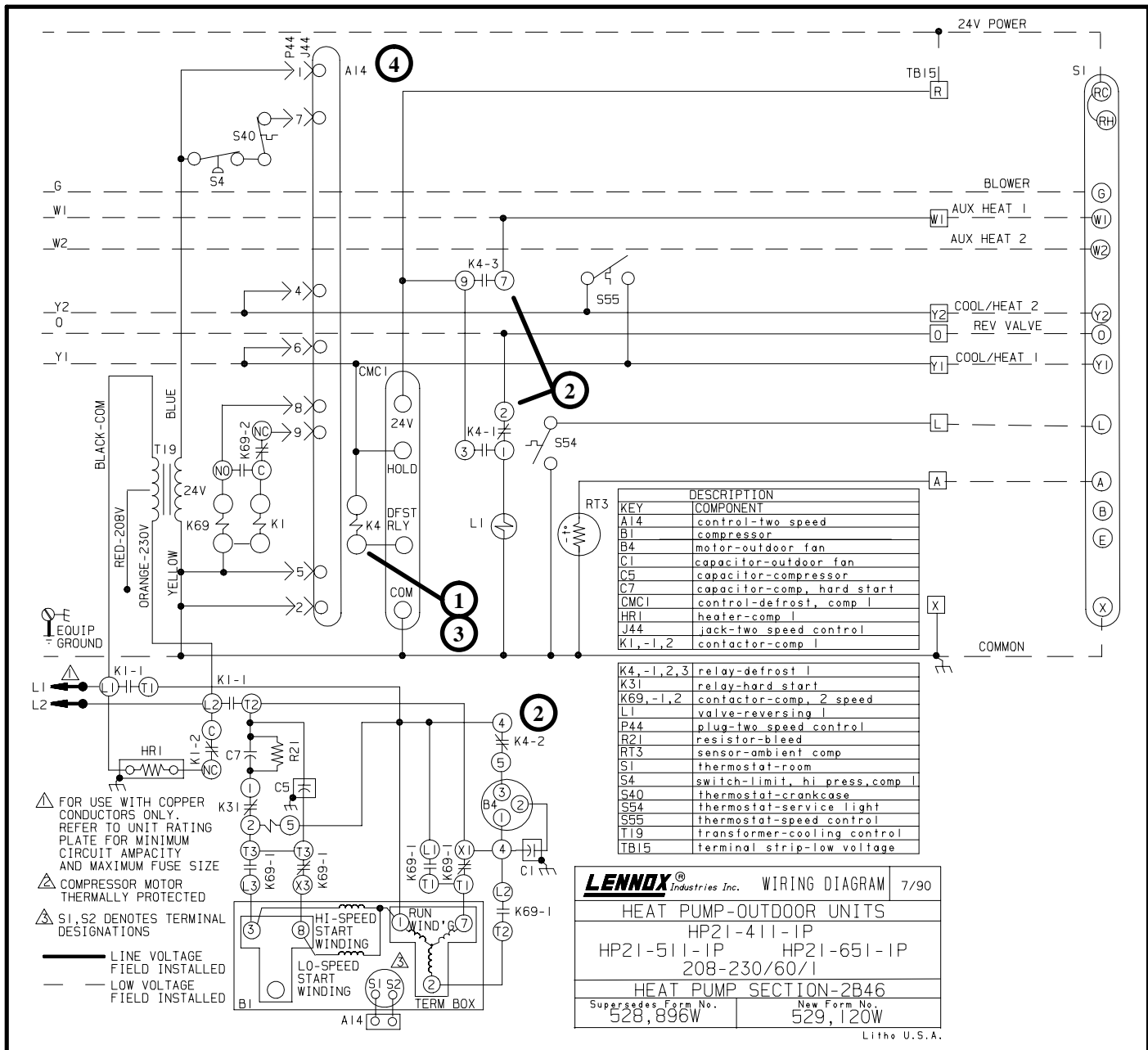

FIGURE 32

G-SINGLE-PHASE DEFROST SEQUENCE

- 1-When the defrost control determines a defrost needs to be initiated it closes an internal relay connected to DEF RLY terminal. Relay K4 is energized. Relay K4 controls defrost.
- 2-When relay K4 energizes, K4-1 switches to energize the reversing valve, K4-2 opens to de-energize the outdoor fan and K4-3 closes to energize auxiliary heat.

3-Refer to the unit component section of this manual for detailed defrost control operation. Defrost is terminated when relay K4 is de-energized.

Thermostat Demand Satisfied

4- When thermostat demand is satisfied or if thermostat is switched OFF or switched to heating mode, all outdoor unit operation stops after a delay of 3 seconds. TSC then completely resets (erase accumulated faults) before cycling through the 5 minute timed-off delay.

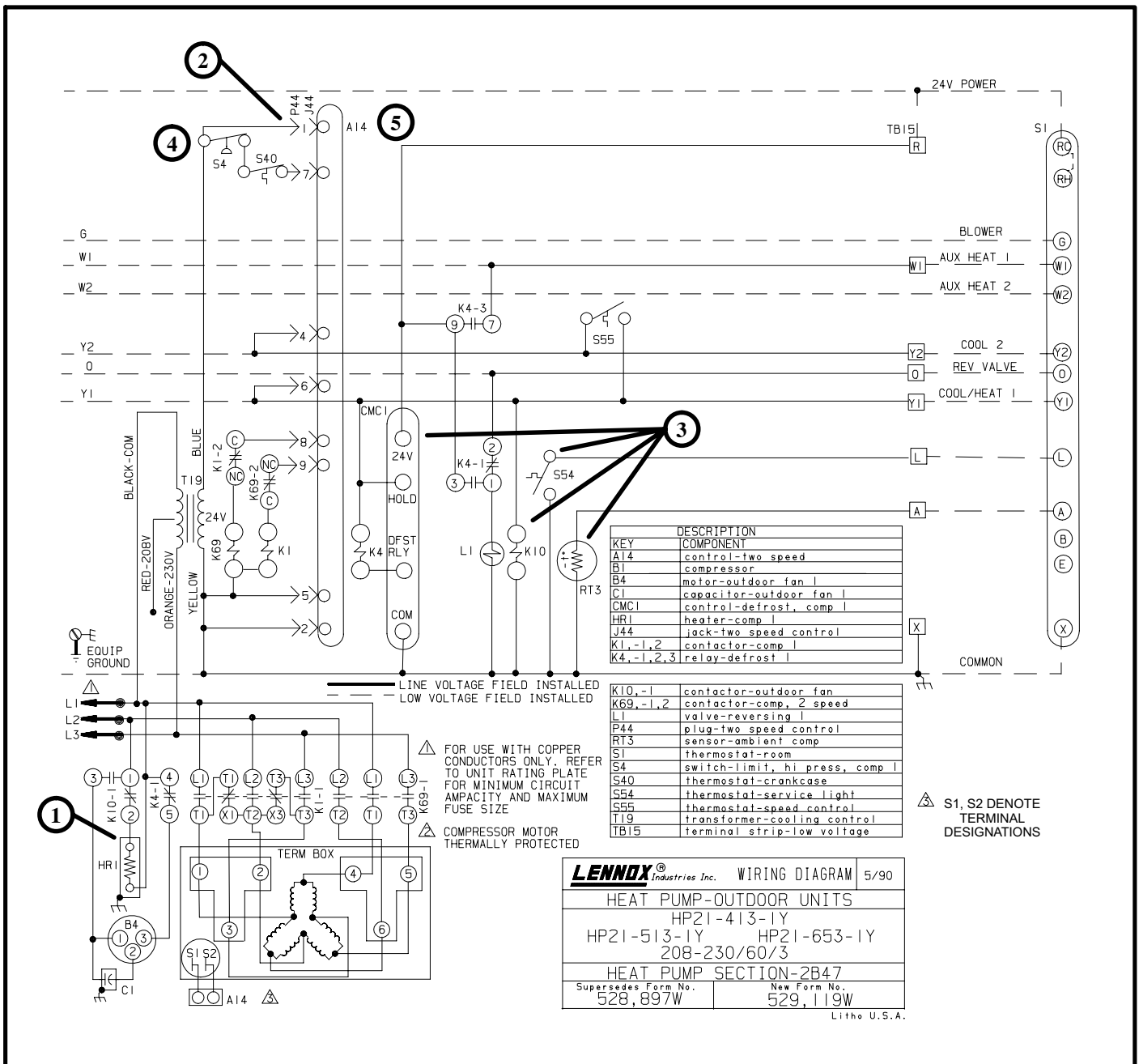

FIGURE 33

H-THREE-PHASE STARTING SEQUENCE

- 1-Line voltage feeds through L1, L2 and L3 to energize outdoor transformer T19 and outdoor unit. Crankcase heater is energized through relay K10-1 outdoor fan contacts.
- 2- Transformer T19 provides 24VAC to TSC and contactors K1 and K69.
- 3- The indoor transformer supplies 24VAC to the indoor unit and the indoor thermostat. Indoor transformer also provides 24VAC power to

- defrost control CMC1, reversing valve L1, outdoor fan relay K10, speed control thermostat S55, service light thermostat S54 and ambient thermistor RT3 in outdoor unit.
- 4- On power-up, 24VAC is fed through JP44-1 and JP44-7 to the TSC. The TSC begins a 10 second power-up delay.
- 5- The TSC begins a 5 minute delay during which the outdoor unit is not operational. After the 5 minute delay, the TSC waits in "OFF" mode for 1st stage or 2nd stage demand.

I-THREE-PHASE COMPRESSOR STARTUP

LOW SPEED

- 1-Low speed demand energizes outdoor fan relay K10 and JP44-6. K10-1 switches to energize the outdoor fan and de-energize the crankcase heater. Outdoor fan begins operating immediately.
- 2-After appropriate time delay and if all safety circuits check out, TSC energizes JP44-9. Contactor K1 is energized through K69-2 N.C. contacts.
- 3-K1 N.O. contacts close to begin compressor low speed startup. K1 N.C. contacts open to disconnect the high speed wiring circuitry.
- 4-Compressor B1 terminal 1 is energized by K1 contacts L1-T1. Compressor terminal 2 is energized by contactor K1 terminal L2-T2. Compressor terminal 3 is energized by contactor K1 terminal L3-T3. This arrangement forms a series DELTA connection to the motor windings for low speed.

HIGH SPEED

- 5-High speed demand energizes JP44-4.
- 6-After appropriate time delay and if all safety circuits check out, TSC energizes JP44-8.
- 7-When contactor K1 is de-energized, contacts K1-1 normally closed contacts form a parallel DELTA connection to the motor windings for high speed.
- 8-Contactor K69 energizes through K1-2 N.C. contacts (speed change delay has reset K1-2 to N.C. position). N.O. K69-1 contacts close to begin compressor high speed startup. Compressor terminal 4 is energized by contactor K69 terminal L1-T1. Compressor terminal 6 is energized by contactor K69 terminal L2-T2. Compressor terminal 5 is energized by contactor K69 terminal L3-T3.

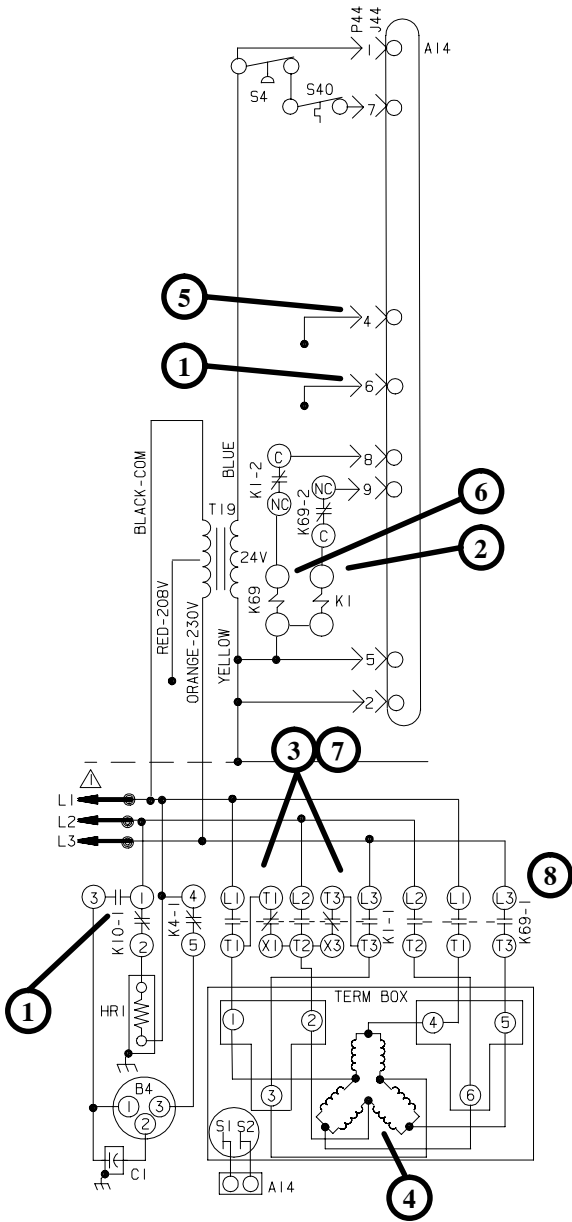

KEY	DESCRIPTION
A14	control-two speed
B1	compressor
B4	motor-outdoor fan I
C1	capacitor-outdoor fan I
CMC1	control-defrost, comp I
HR1	heater-comp I
J44	jack-two speed control
K1,-1,2	contactor-comp I
K4,-1,2,3	relay-defrost I

K10,-1	contactor-outdoor fan
K69,-1,2	contactor-comp, 2 speed
L1	valve-reversing I
P44	plug-two speed control
RT3	sensor-ambient comp
SI	thermostat-room
S4	switch-limit, hi press, comp I
S40	thermostat-crankcase
S54	thermostat-service light
S55	thermostat-speed control
T19	transformer-cooling control
TB15	terminal strip-low voltage

FIGURE 34

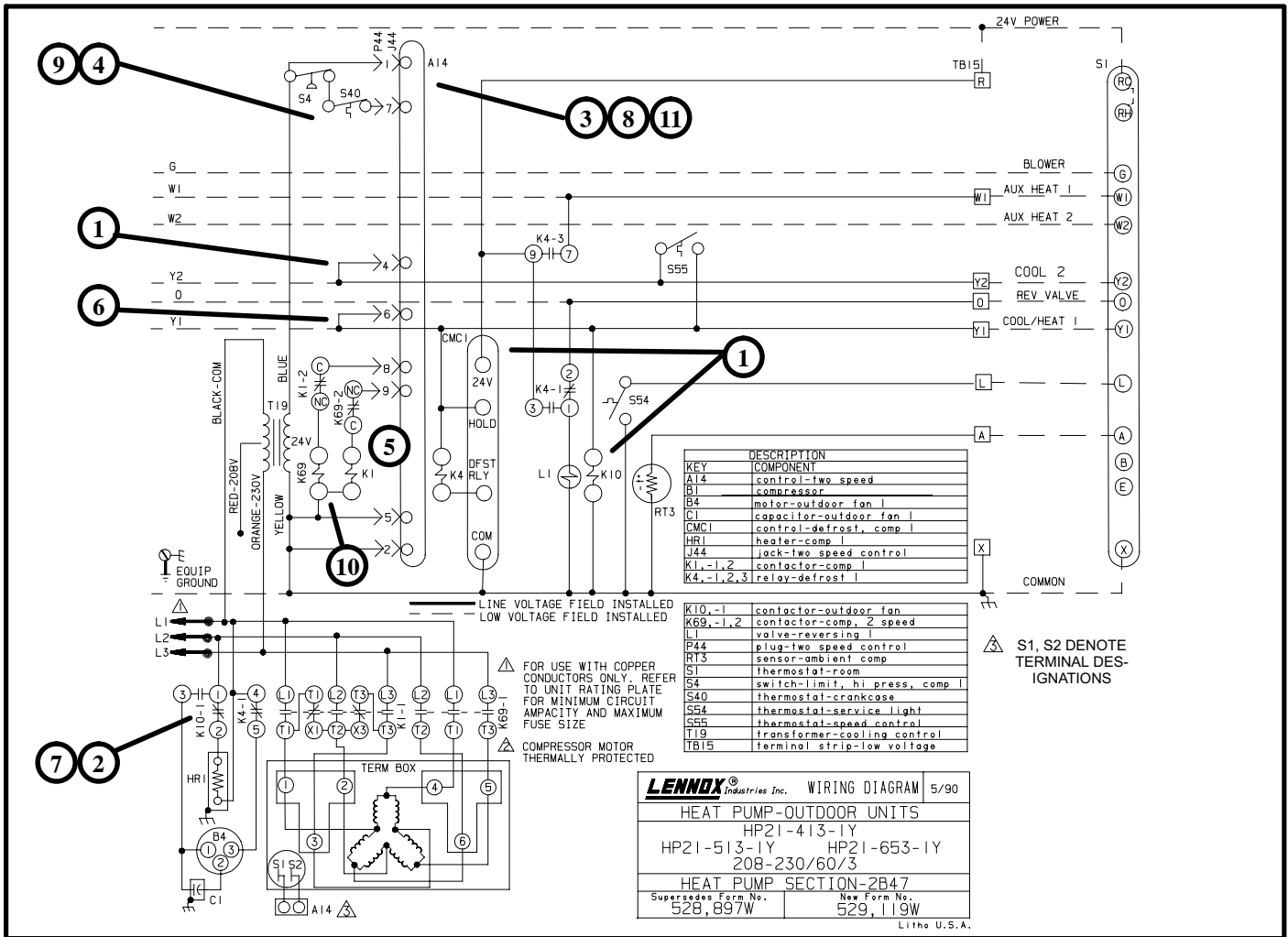

FIGURE 35

J-THREE-PHASE COOLING SEQUENCE

1- 1st stage cooling demand energizes TB15-Y1 and TB15-O. TB15-O energizes reversing valve L1. TB15-Y1 energizes TSC terminal JP44-6, relay K10 and defrost control terminal HOLD. Defrost control monitors liquid line temperature and turns off defrost control when liquid line rises above 65°F.

NOTE-2nd stage cooling demand may be energized directly without passing through 1st stage.

- 2- Relay contacts K10-1 switch to energize the outdoor fan and to de-energize the crankcase heater.
- 3- TSC delays 3 seconds before responding to the new command.
- 4- If the unit is changing from 2nd stage to 1st stage demand, TSC initiates speed change delay and de-energizes JP44-8 and JP44-9 to stop all unit operation for 60±5 seconds. Outdoor fan continues to operate. After TSC completes the 60±5 second speed change delay or if the unit is starting-up in 1st stage directly from OFF mode, TSC checks safety circuits by looking for 24VAC at JP44-7 and by checking resistance through wires connected to S1 and S2.
- 5- If all safety circuits check-out, TSC energizes K1 and compressor begins low speed startup.

- 6- 2nd stage cooling demand energizes TB15-Y1, TB15-Y2 and TB15-O. TB15-Y2 energizes TSC terminal JP44-4. TB15-Y1 energizes TSC terminal JP44-6, defrost control terminal HOLD and outdoor fan relay K10.
- 7- Relay contacts K10-1 switch to energize the outdoor fan and to de-energize the crankcase heater.
- 8- TSC delays 3 seconds before responding.
- 9- If the unit is changing from 1st stage to 2nd stage demand, the TSC initiates speed change delay and de-energizes JP44-8 and JP44-9 to stop all unit operation for 60±5 seconds. After TSC completes the 60±5 second speed change delay or if the unit is starting-up in 2nd stage directly from OFF mode, TSC checks safety circuits by looking for 24VAC at JP44-7 and by checking resistance through wires connected to S1 and S2.
- 10- If all safety circuits check-out, TSC energizes K69. Compressor begins high speed startup.
- 11- When thermostat demand is satisfied or if thermostat is switched OFF or switched to heating mode, all outdoor unit operation stops after a delay of 3 seconds. TSC then completely resets (erase accumulated faults) before beginning a 5 minute timed-off delay.

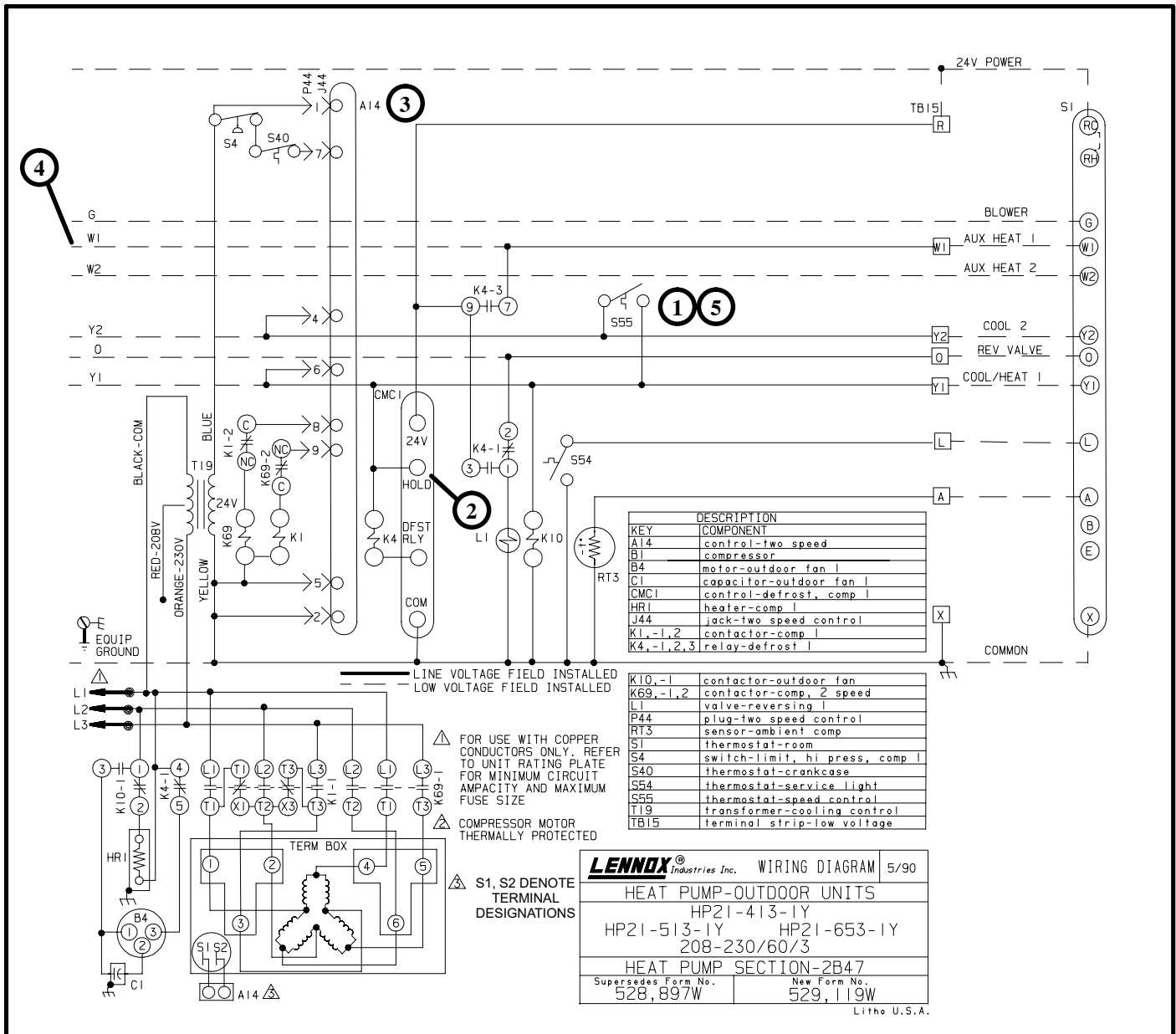

FIGURE 36

K-THREE-PHASE HEATING SEQUENCE

- 1-Speed control thermostat S55 determines whether the compressor is to operate on high or low speed based on outdoor temperature. If outdoor temperature drops below set temperature, S55 closes to shunt across Y2. When Y2 is shunted, a 2nd stage demand is sent to the two-speed control and the compressor runs on high speed. If outdoor temperature rises above set temperature, S55 opens and the compressor runs on low speed.
- 2-1st stage demand energizes TB15-Y1. TB15-Y1 energizes TSC, speed control thermostat S55 and defrost control terminal HOLD. Defrost control initializes timing sequence.
NOTE-2nd stage heating demand may be energized directly without passing through 1st stage.
- 3- TSC delays 3 seconds before responding to the new command. Then

- compressor begins operating at low or high speed as determined by speed control thermostat S55.
- 2nd stage heating demand energizes TB15-Y1 and TB15-W1. TB15-Y1 energizes TSC, speed control thermostat S55 and defrost control terminal HOLD. The compressor continues to operate at low or high speed as determined by speed control thermostat S55. TB15- W1 energizes the indoor auxiliary heat relay for 2nd stage heat.
- 5-Speed control thermostat can open or close during 1st stage or 2nd stage heating operation. When S55 opens, the compressor runs on low speed. When S55 closes, the compressor runs on high speed. If speed control thermostat S55 opens or closes during compressor operation, TSC initiates speed change delay and stops all unit operation for 60±5 seconds (indoor unit continues to operate and if 2nd stage thermostat demand is present auxiliary heat continues operate). If all safety circuits check-out, TSC energizes compressor.

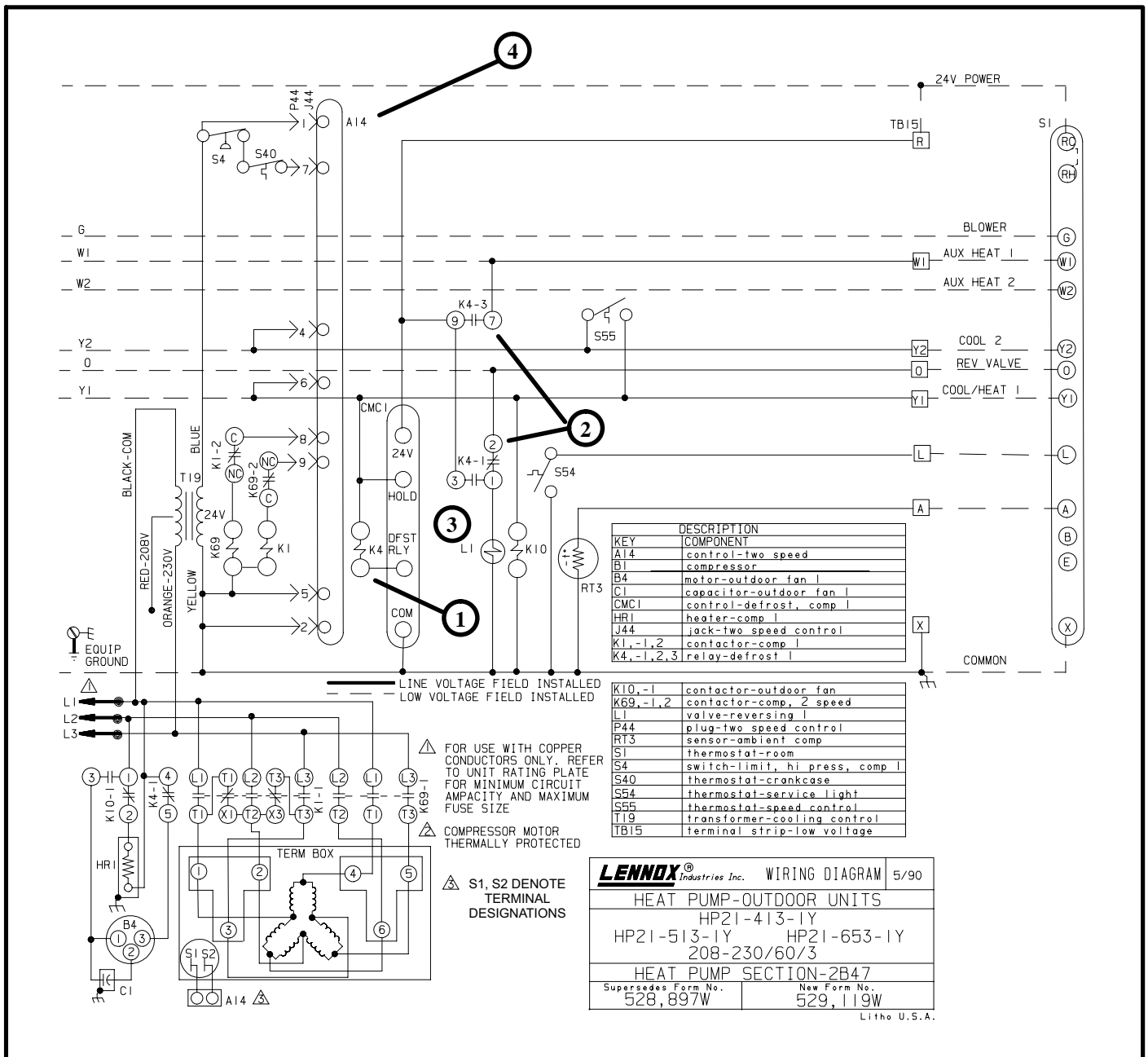

FIGURE 37

L-THREE-PHASE DEFROST SEQUENCE

- 1- When the defrost control determines a defrost needs to be initiated it closes an internal relay connected to DEF RLY terminal. Relay K4 is energized. Relay K4 controls defrost.
- 2- When relay K4 energizes, K4-1 switches to energize the reversing valve, K4-2 opens to de-energize the outdoor fan and K4-3 closes to energize auxiliary heat.

- 3- Refer to the unit component section of this manual for detailed defrost control operation. Defrost is terminated when relay K4 is de-energized.

Thermostat Demand Satisfied

- 4- When thermostat demand is satisfied or if thermostat is switched OFF or switched to heating mode, all outdoor unit operation stops after a delay of 3 seconds. TSC then completely resets (erase accumulated faults) before cycling through the 5 minute timed-off delay.

HP21-2/-3 Wiring (Single Phase Units Shown)

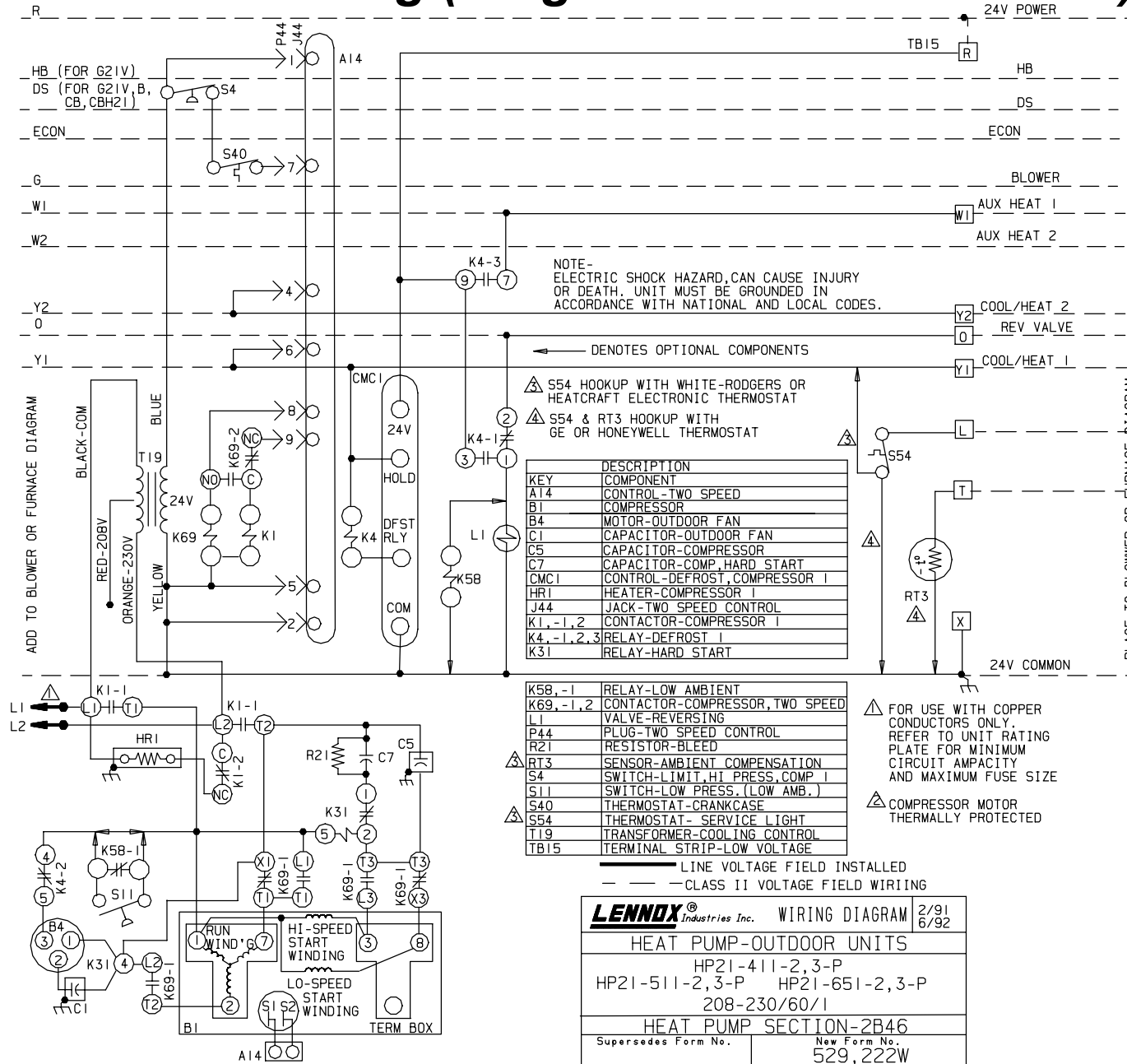

LENNOX Industries Inc. WIRING DIAGRAM 2/91
6/92

HEAT PUMP-OUTDOOR UNITS

HP21-411-2,3-P
HP21-511-2,3-P HP21-651-2,3-P
208-230/60/1

HEAT PUMP SECTION-2B46

Supersedes Form No. New Form No.
529,222W

HP21-2/-3 Wiring (Three Phase Units Shown)

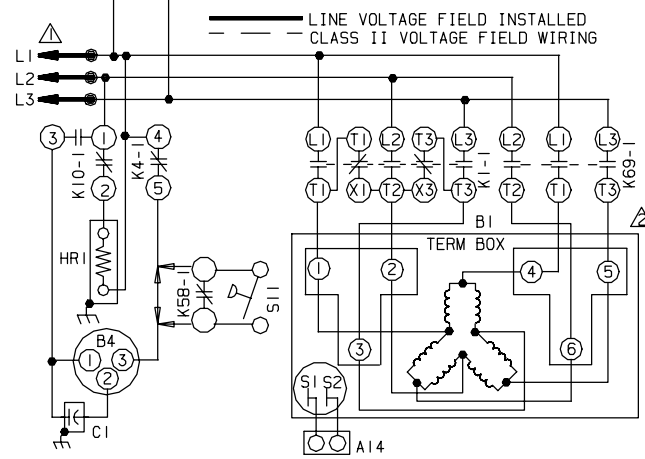
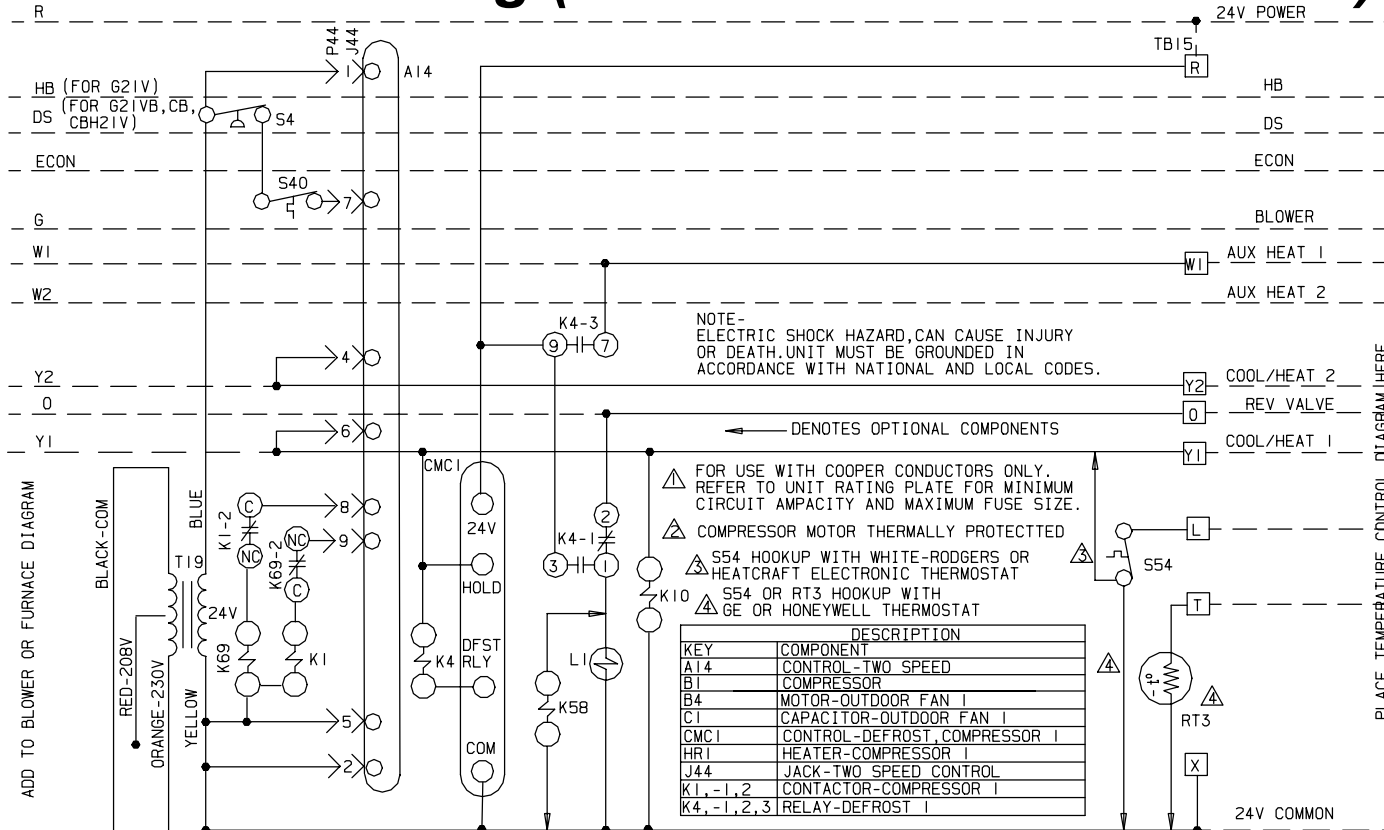

DESCRIPTION	
KEY	COMPONENT
A14	CONTROL - TWO SPEED
B1	COMPRESSOR
B4	MOTOR-OUTDOOR FAN I
C1	CAPACITOR-OUTDOOR FAN I
CMC1	CONTROL-DEFROST, COMPRESSOR I
HR1	HEATER-COMPRESSOR I
J44	JACK-TWO SPEED CONTROL
K1, -1, 2	CONTACTOR-COMPRESSOR I
K4, -1, 2, 3	RELAY-DEFROST I

K10, -1	CONTACTOR-OUTDOOR FAN
K58, -1	RELAY-LOW AMBIENT
K69, -1, 2	CONTACTOR-COMPRESSOR, TWO SPEED
L1	VALVE-REVERSING
P44	PLUG-TWO SPEED CONTROL
RT3	SENSOR AMBIENT COMPENSATION
S4	SWITCH-LIMIT, HI PRESS, COMP I
S11	SWITCH-LOW PRESS. (LOW AMB.)
S40	THERMOSTAT-CRANKCASE
S54	THERMOSTAT-SERVICE LIGHT
T19	TRANSFORMER-COOLING CONTROL
TB15	TERMINAL STRIP-LOW VOLTAGE

LENNOX [®] Industries Inc.	WIRING DIAGRAM	2/91 6/92
HEAT PUMP-OUTDOOR UNITS		
HP21-413-2, 3-Y		
HP21-513-2, 3-Y		
HP21-653-2, 3-Y 208-230/60/3		
HEAT PUMP SECTION-2B47		
Supersedes Form No.	New Form No. 529, 221W	

HP21-4/-5 Wiring (Single Phase Units Shown)

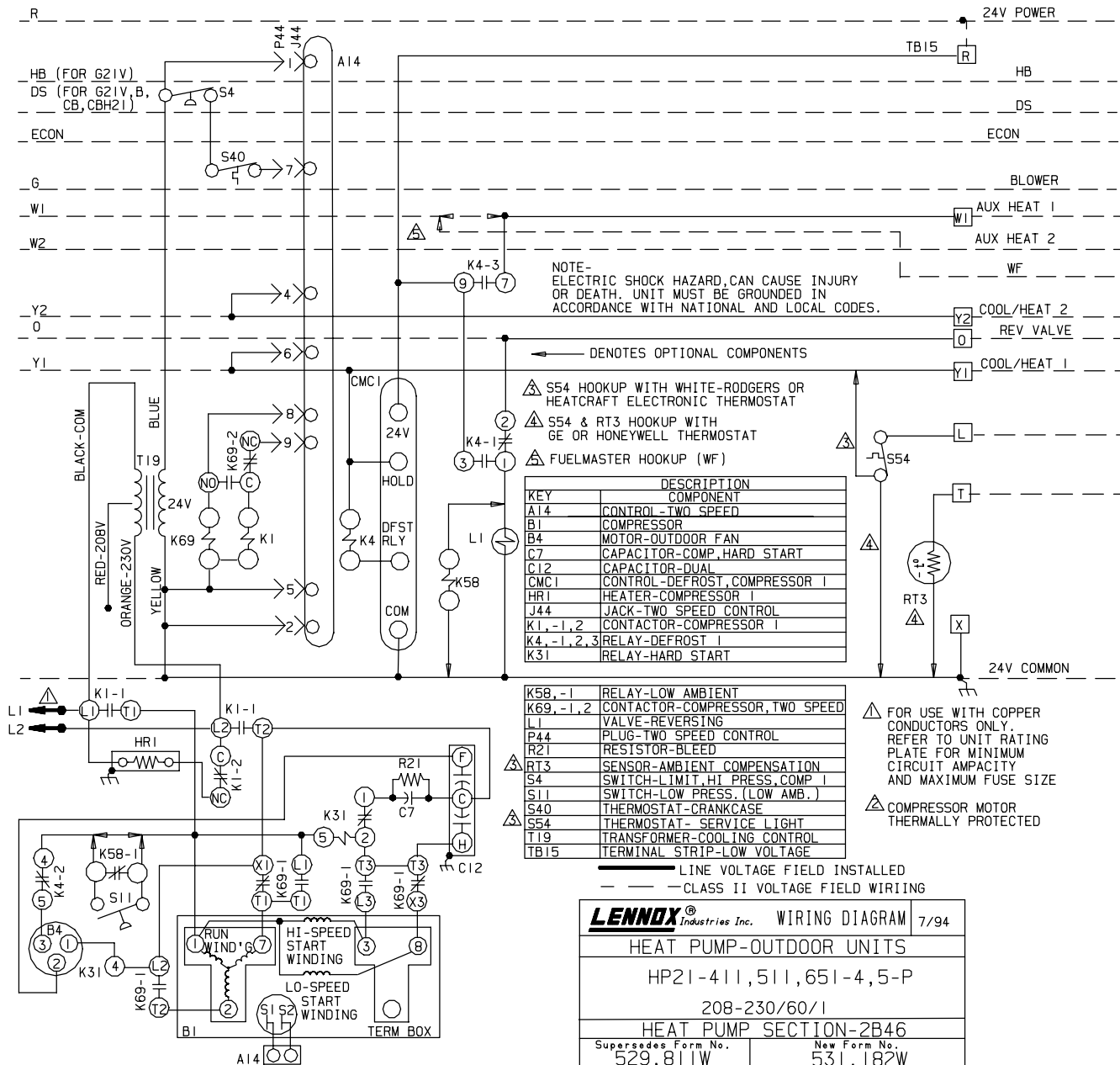

LENNOX Industries Inc. WIRING DIAGRAM 7/94

HEAT PUMP - OUTDOOR UNITS

HP21-411, 511, 651-4, 5-P

208-230/60/1

HEAT PUMP SECTION-2B46

Supersedes Form No. 529, 811W	New Form No. 531, 182W
----------------------------------	---------------------------

© 1994 Lennox Industries Inc. Litho U.S.A.

HP21-4/-5 Wiring (Three Phase Units Shown)

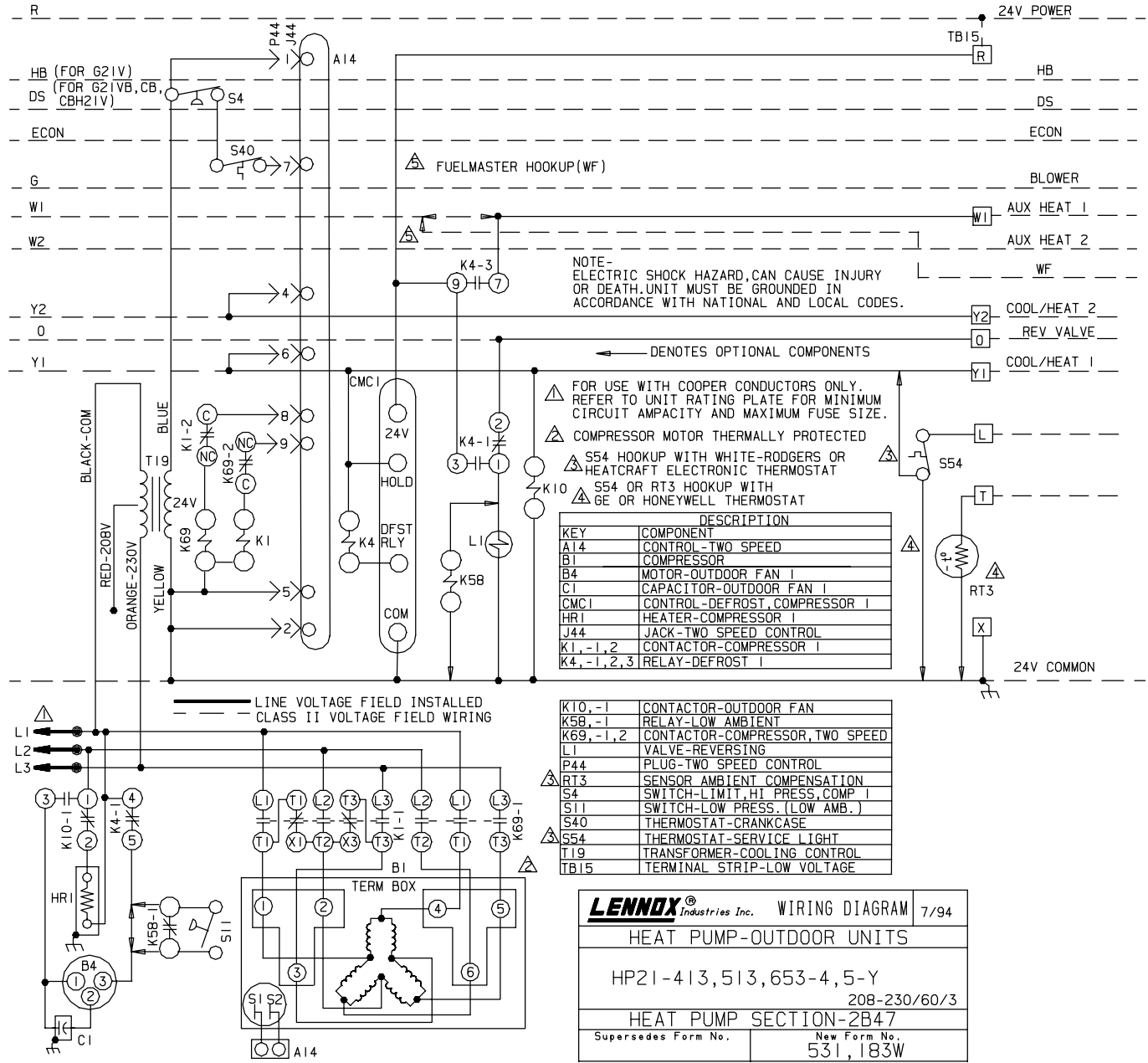

LENNOX Industries Inc. WIRING DIAGRAM 7/94
HEAT PUMP-OUTDOOR UNITS
HP21-413, 513, 653-4, 5-Y
208-230/60/3
HEAT PUMP SECTION-2B47
Supersedes Form No. New Form No.
531, 183W
©1994 Lennox Industries Inc. Litho U.S.A.

HP21-36-230/60-230 Wiring

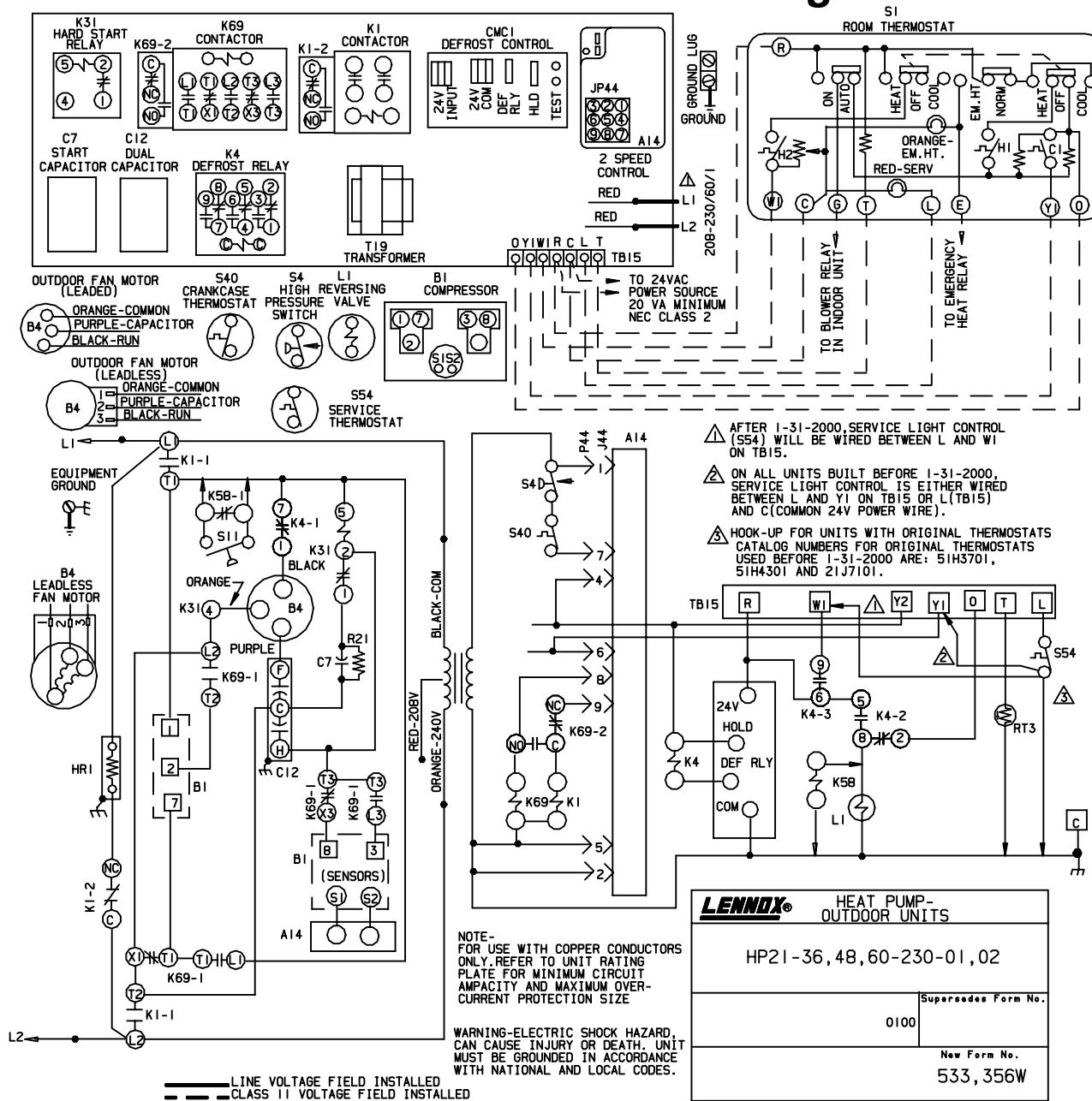

LENNOX® HEAT PUMP-OUTDOOR UNITS	
HP21-36, 48, 60-230-01, 02	
Supersedes Form No. 0100	
New Form No. 533, 356W	

©2000 Lennox Industries Inc. Litho U.S.A.

HP21-36-233/60-233 Wiring

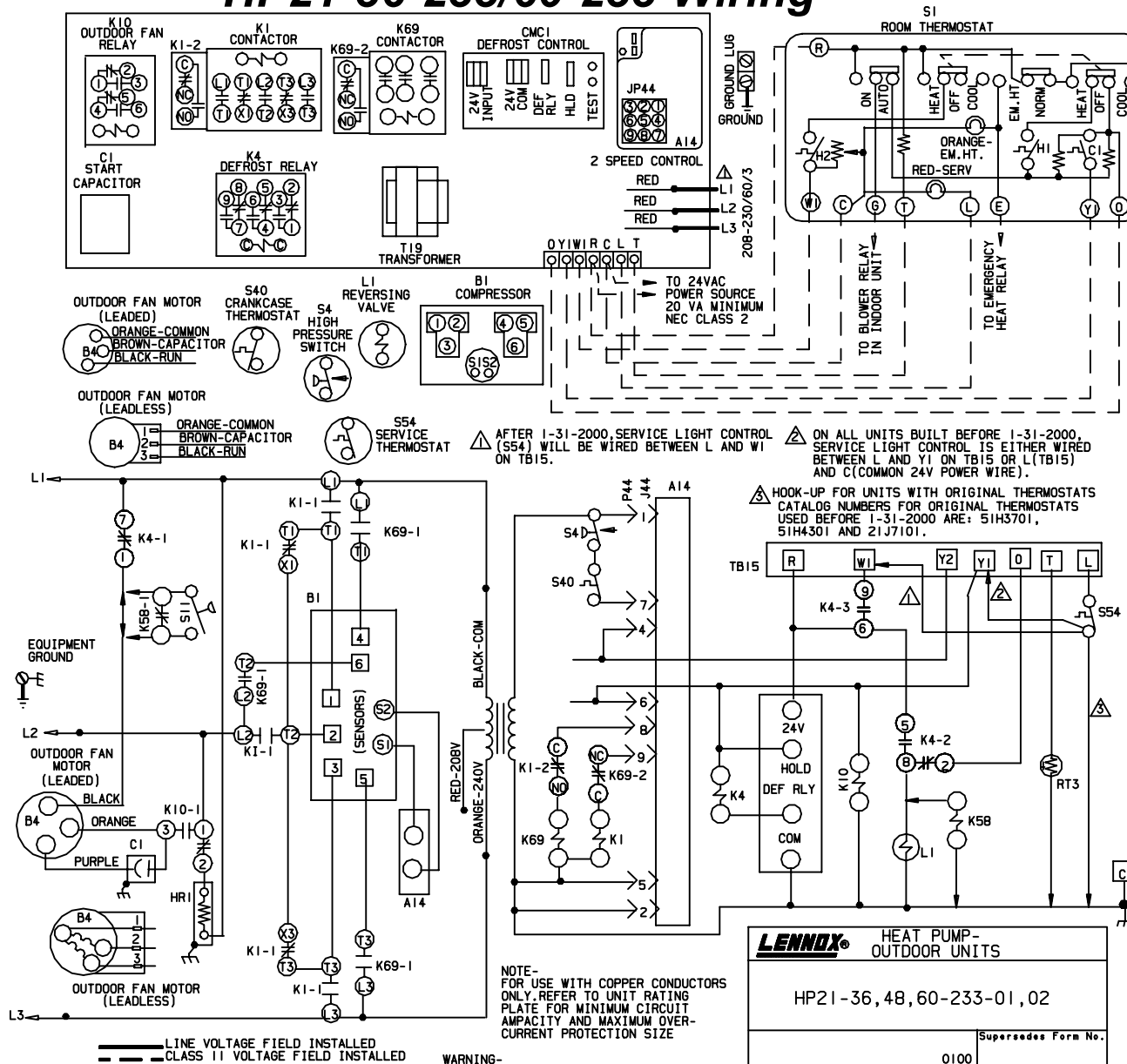

⚠ AFTER 1-31-2000, SERVICE LIGHT CONTROL (S54) WILL BE WIRED BETWEEN L AND W1 ON TB15.

⚠ ON ALL UNITS BUILT BEFORE 1-31-2000, SERVICE LIGHT CONTROL IS EITHER WIRED BETWEEN L AND Y1 ON TB15 OR L (TB15) AND C (COMMON 24V POWER WIRE).

⚠ HOOK-UP FOR UNITS WITH ORIGINAL THERMOSTATS CATALOG NUMBERS FOR ORIGINAL THERMOSTATS USED BEFORE 1-31-2000 ARE: 51H3701, 51H4301 AND 21J7101.

NOTE- FOR USE WITH COPPER CONDUCTORS ONLY. REFER TO UNIT RATING PLATE FOR MINIMUM CIRCUIT AMPACITY AND MAXIMUM OVER-CURRENT PROTECTION SIZE

WARNING- ELECTRIC SHOCK HAZARD, CAN CAUSE INJURY OR DEATH. UNIT MUST BE GROUNDED IN ACCORDANCE WITH NATIONAL AND LOCAL CODES.

LENNOX® HEAT PUMP-OUTDOOR UNITS	
HP21-36, 48, 60-233-01, 02	
0100	Supersedes Form No.
	New Form No.
	533, 357W

HP21-36-230 / 60-230-3 UNITS SINGLE PHASE

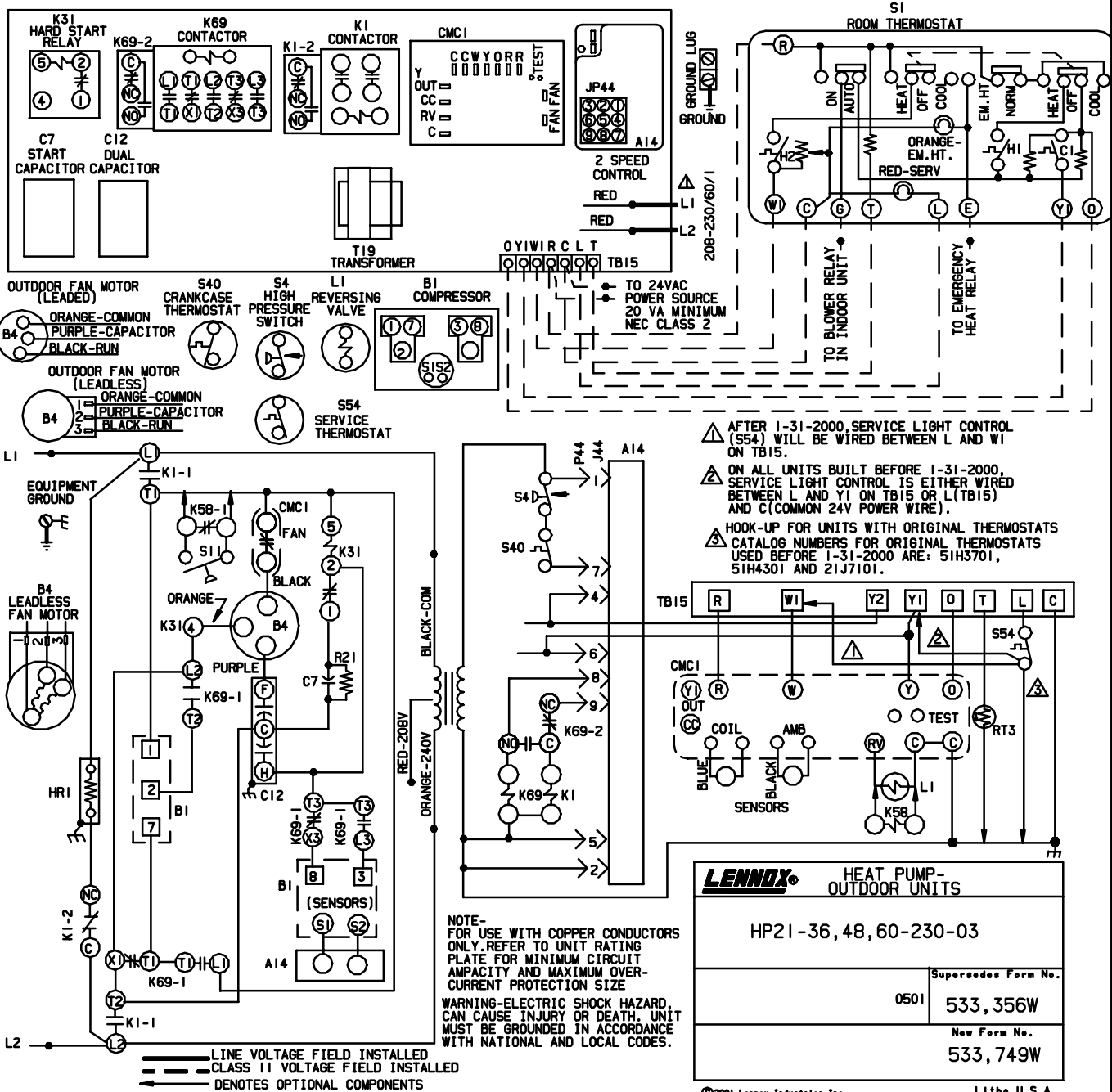

LENNOX HEAT PUMP-
OUTDOOR UNITS

HP21-36, 48, 60-230-03

	Supersedes Form No.
0501	533, 356W
	New Form No.
	533, 749W

©2001 Lennox Industries Inc. Litho U.S.A.

HP21-36-230 / 60-230-3 UNITS OPERATION SEQUENCE

SINGLE-PHASE COOLING SEQUENCE

The TSC two-speed control has an external temperature probe to lockout low speed during low temperatures, plus a potentiometer used for setting the low speed lock out temperature. The adjustment range is 38° to 55°. This lockout will occur in heating and cooling mode.

1- 1st stage cooling demand energizes TB15-Y1 and TB15-O. TB15-O sends signal to O on defrost board which energizes reversing valve L1. TB15-Y1 energizes TSC terminal JP44-6.

NOTE-2nd stage cooling demand may be energized directly without passing through 1st stage.

2- TSC delays 3 seconds before responding to the new command.

3- If the unit is changing from 2nd stage to 1st stage demand, TSC initiates speed change delay and de-energizes JP44-8 and JP44-9 to stop all unit operation for 60±5 seconds. After TSC completes the 60±5 second speed change delay or if the unit is starting-up in 1st stage directly from OFF mode, TSC checks safety circuits by looking for 24VAC at JP44-7 and by checking resistance through wires connected to S1 and S2.

4- If all safety circuits check-out, TSC energizes K1 and compressor begins low speed startup.

5- 2nd stage cooling demand energizes TB15-Y1, TB15-Y2 and TB15-O. TB15-Y2 energizes TSC terminal JP44-4. TB15-Y1 energizes TSC terminal JP44-6.

6- TSC delays 3 seconds before responding.

7- If the unit is changing from 1st stage to 2nd stage demand, the TSC initiates speed change delay and de-energizes JP44-8 and JP44-9 to stop all unit operation for 60±5 seconds. After TSC completes the 60±5 second speed change delay or if the unit is starting-up in 2nd stage directly from OFF mode, TSC checks safety circuits by looking for 24VAC at JP44-7 and by checking resistance through wires connected to S1 and S2.

8- If all safety circuits check-out, TSC energizes K1 and K69. Compressor begins high speed startup.

9- When thermostat demand is satisfied or if thermostat is switched OFF or switched to heating mode, all outdoor unit operation stops after a delay of 3 seconds. TSC then completely resets (erase accumulated faults) before beginning a 5 minute timed-off delay.

SINGLE-PHASE HEATING SEQUENCE

10- 1st stage demand energizes TB15-Y1. TB15-Y1 energizes TSC, and defrost control. Defrost control initializes timing sequence.

NOTE-2nd stage heating demand may be energized directly without passing through 1st stage.

11- TSC delays 3 seconds before responding to the new command. Then compressor begins operating at low or high speed depending on the outdoor ambient.

12- 2nd stage heating demand energizes TB15-Y1 and TB15-W1. TB15-Y1 energizes TSC. The compressor continues to operate at low or high speed as determined by the outdoor ambient. W1 energizes the indoor auxiliary heat relay for 2nd stage heat.

DEFROST SEQUENCE

Upon initial power up or first heating demand after cooling mode, a "sacrificial" defrost operation will occur in order to calibrate the board. Calibration will occur after accumulated compressor run time of 34 minutes and coil temperature is below 35°.

13- Y1 is energized in HEAT mode, de-energizing reversing valve.

14- Compressor run time of 34 minutes accumulated. Defrost begins. N.C. FAN terminal on board remains open, allowing fan to cycle during defrost.

15- Defrost will last a maximum of 14 minutes or until the coil temperature sensed at the coil probe exceeds the selected pin termination temperature. Pin values are 50°, 60°, 70° and 80°. (Factory setting is 70°).

HP21-36-230 / 60-230-3 UNITS THREE PHASE

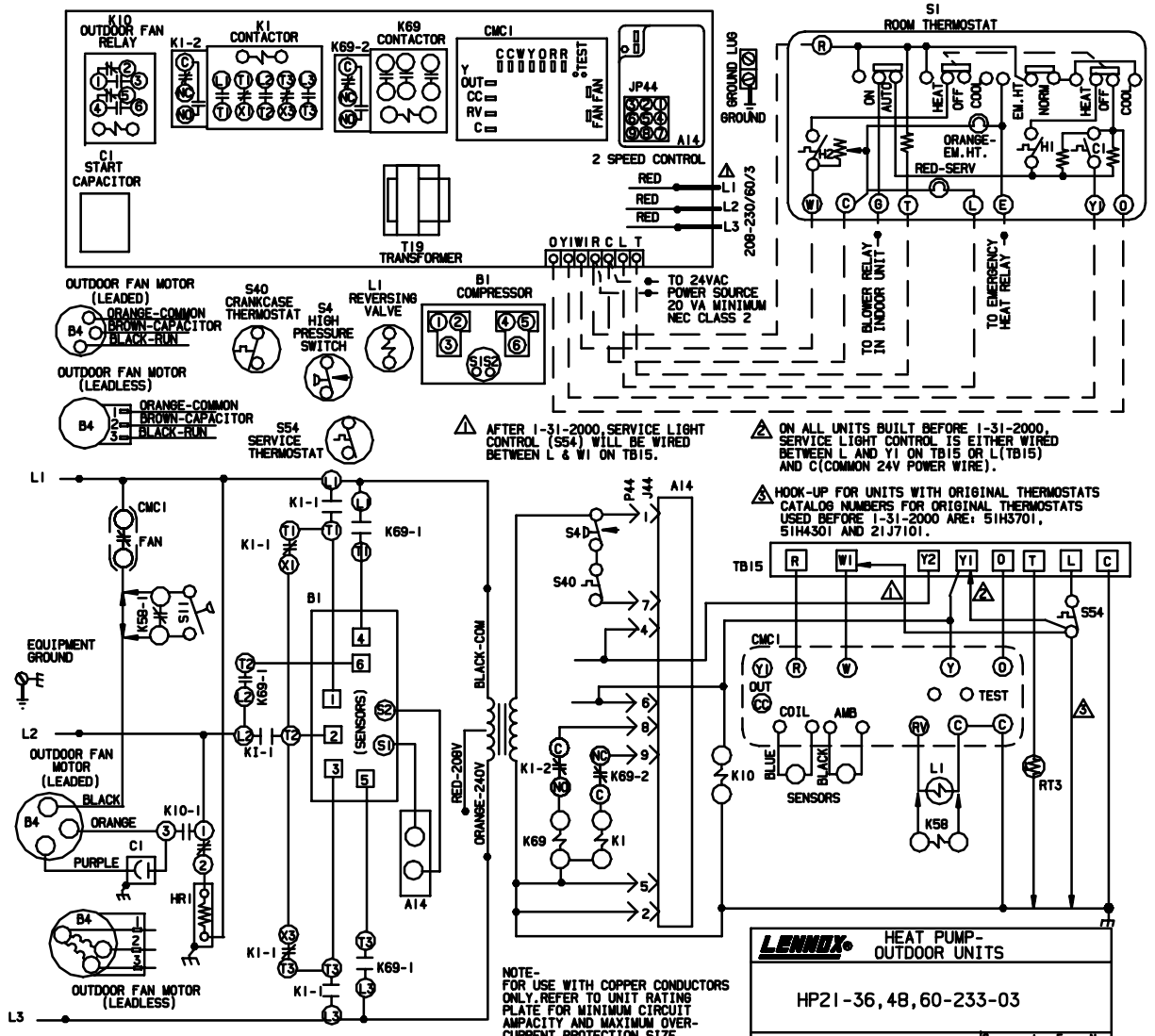

⚠ AFTER 1-31-2000, SERVICE LIGHT CONTROL (S54) WILL BE WIRED BETWEEN L & W1 ON TB15.

⚠ ON ALL UNITS BUILT BEFORE 1-31-2000, SERVICE LIGHT CONTROL IS EITHER WIRED BETWEEN L AND Y1 ON TB15 OR L(TB15) AND C (COMMON 24V POWER WIRE).

⚠ HOOK-UP FOR UNITS WITH ORIGINAL THERMOSTATS CATALOG NUMBERS FOR ORIGINAL THERMOSTATS USED BEFORE 1-31-2000 ARE: 51H3701, 51H4301 AND 21J7101.

— LINE VOLTAGE FIELD INSTALLED
 - - - CLASS II VOLTAGE FIELD INSTALLED
 ← DENOTES OPTIONAL COMPONENTS

NOTE-
 FOR USE WITH COPPER CONDUCTORS ONLY, REFER TO UNIT RATING PLATE FOR MINIMUM CIRCUIT AMPACITY AND MAXIMUM OVER-CURRENT PROTECTION SIZE

WARNING-
 ELECTRIC SHOCK HAZARD, CAN CAUSE INJURY OR DEATH. UNIT MUST BE GROUNDED IN ACCORDANCE WITH NATIONAL AND LOCAL CODES

LENNOX HEAT PUMP- OUTDOOR UNITS	
HP21-36, 48, 60-233-03	
0501	Supersedes Form No. 533, 357W
New Form No. 533, 750W	

©2001 Lennox Industries Inc. Litho U.S.A.

HP21-36-230 / 60-230-3 UNITS OPERATION SEQUENCE

THREE-PHASE COOLING SEQUENCE

The TSC two-speed control has an external temperature probe to lockout low speed during low temperatures, plus a potentiometer used for setting the low speed lock out temperature. The adjustment range is 38° to 55°. This lockout will occur in heating and cooling mode.

1- 1st stage cooling demand energizes TB15-Y1 and TB15-O. TB15-O sends signal to O on defrost board which energizes reversing valve L1. TB15-Y1 energizes TSC terminal JP44-6.

NOTE-2nd stage cooling demand may be energized directly without passing through 1st stage.

2- TSC delays 3 seconds before responding to the new command.

3- If the unit is changing from 2nd stage to 1st stage demand, TSC initiates speed change delay and de-energizes JP44-8 and JP44-9 to stop all unit operation for 60±5 seconds. After TSC completes the 60±5 second speed change delay or if the unit is starting-up in 1st stage directly from OFF mode, TSC checks safety circuits by looking for 24VAC at JP44-7 and by checking resistance through wires connected to S1 and S2.

4- If all safety circuits check-out, TSC energizes K1 and compressor begins low speed startup.

5- 2nd stage cooling demand energizes TB15-Y1, TB15-Y2 and TB15-O. TB15-Y2 energizes TSC terminal JP44-4. TB15-Y1 energizes TSC terminal JP44-6.

6- TSC delays 3 seconds before responding.

7- If the unit is changing from 1st stage to 2nd stage demand, the TSC initiates speed change delay and de-energizes JP44-8 and JP44-9 to stop all unit operation for 60±5 seconds. After TSC completes the 60±5 second speed change delay or if the unit is starting-up in 2nd stage directly from OFF mode, TSC checks safety circuits by looking for 24VAC at JP44-7 and by checking resistance through wires connected to S1 and S2.

8- If all safety circuits check-out, TSC energizes K1 and K69. Compressor begins high speed startup.

9- When thermostat demand is satisfied or if thermostat is switched OFF or switched to heating mode, all outdoor unit operation stops after a delay of 3 seconds. TSC then completely resets (erase accumulated faults) before beginning a 5 minute timed-off delay.

THREE-PHASE HEATING SEQUENCE

10- 1st stage demand energizes TB15-Y1. TB15-Y1 energizes TSC, and defrost control. Defrost control initializes timing sequence.

NOTE-2nd stage heating demand may be energized directly without passing through 1st stage.

11- TSC delays 3 seconds before responding to the new command. Then compressor begins operating at low or high speed depending on the outdoor ambient.

12- 2nd stage heating demand energizes TB15-Y1 and TB15-W1. TB15-Y1 energizes TSC. The compressor continues to operate at low or high speed as determined by the outdoor ambient. W1 energizes the indoor auxiliary heat relay for 2nd stage heat.

DEFROST SEQUENCE

Upon initial power up or first heating demand after cooling mode, a "sacrificial" defrost operation will occur in order to calibrate the board. Calibration will occur after accumulated compressor run time of 34 minutes and coil temperature is below 35°.

13- Y1 is energized in HEAT mode, de-energizing reversing valve.

14- Compressor run time of 34 minutes accumulated. Defrost begins. N.C. outdoor fan relay K10 remains open, allowing fan to cycle during defrost.

15- Defrost will last a maximum of 14 minutes or until the coil temperature sensed at the coil probe exceeds the selected pin termination temperature. Pin values are 50°, 60°, 70° and 80°. (Factory setting is 70°).

VIII-TROUBLESHOOTING FLOWCHARTS

The following flowcharts show how to diagnose problems in two-speed heat pumps equipped with TSC control. Table 19 shows how to determine if the TSC is functioning. Tables 20a and 20b show how to correlate TSC diagnostics to the unit.

Follow the flowcharts step by step. Disconnect as few

wires as possible. Any time a repair is made, reassemble the unit and retest for operation. If the unit does not operate, recheck up to that point and then continue through the chart. Occasionally more than one specific problem may exist. Do as little disassembly as possible and double check your diagnosis before replacing components.

Be sure to remove all jumper wires and replace all wire connections and access panels before placing unit back in service.

TABLE 19

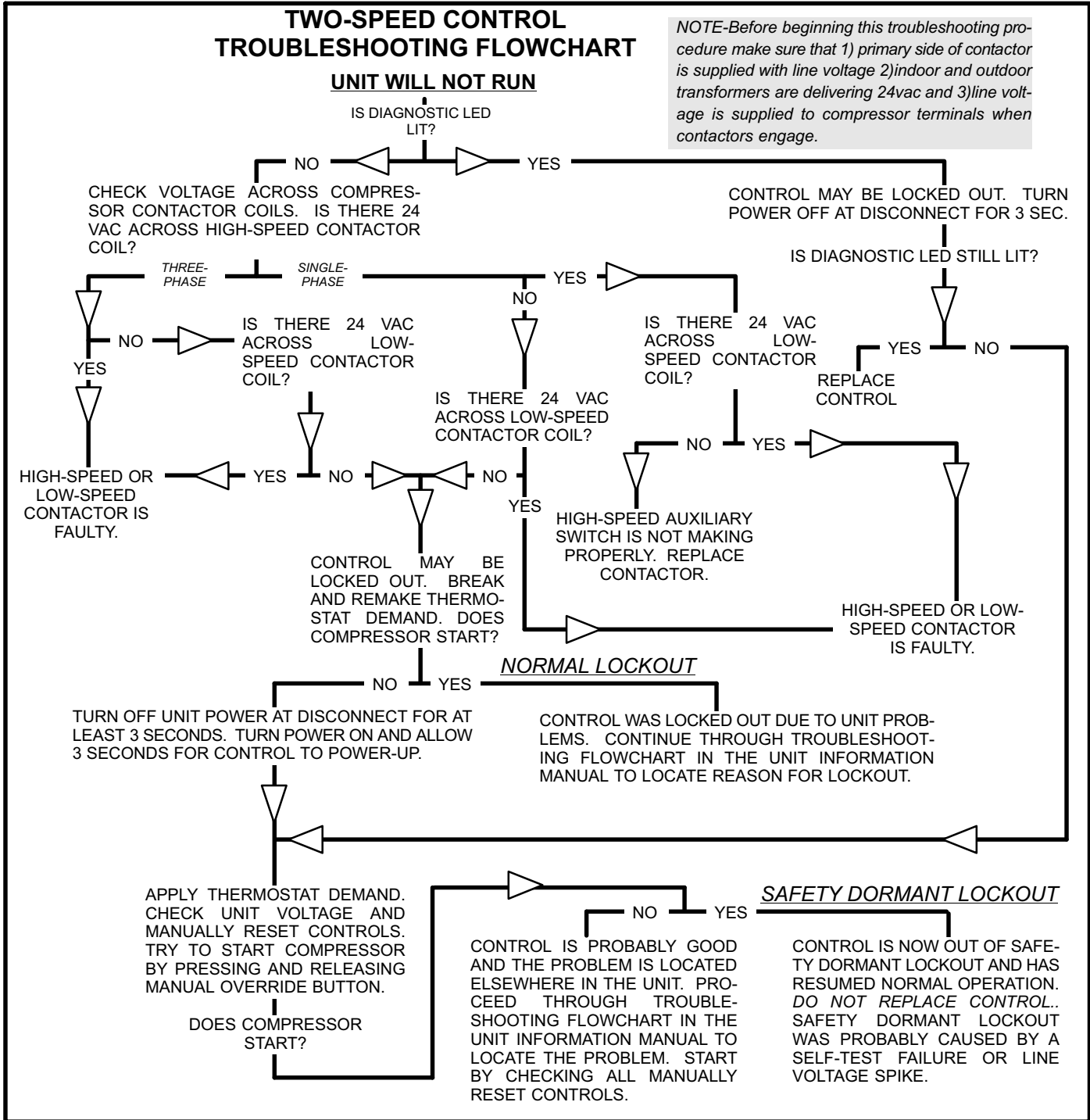
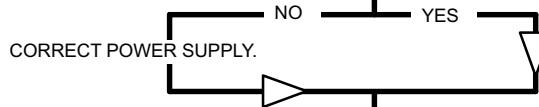

TABLE 20a

HP21 UNIT CONTROLS DIAGNOSTICS

**START
HERE**

CHECK SUPPLY VOLTAGE. IS SUPPLY VOLTAGE WITHIN RANGE SHOWN ON UNIT RATING PLATE?



MANUALLY RESET HIGH PRESSURE SWITCH S4 IN OUTDOOR UNIT IF TRIPPED.

CHOOSE COOLING OR HEATING MODE

HIGH SPEED COOLING

- 1- TURN INDOOR THERMOSTAT TO OFF POSITION.
- 2- SET INDOOR THERMOSTAT TO LOWEST TEMPERATURE SETTING.
- 3- TURN INDOOR THERMOSTAT TO COOL MODE.
- 4- IF POWER TO OUTDOOR UNIT HAS BEEN OFF, WAIT AT LEAST 10 SECONDS TO ALLOW TSC TO POWER-UP.
- 5- PUSH AND RELEASE THE OVERRIDE BUTTON ON THE TSC TO BY-PASS THE 5-MINUTE TIMED-OFF DELAY.
- 6- ALLOW 1 MINUTE FOR THE UNIT TO START.

DOES UNIT START AND RUN ON HIGH SPEED?

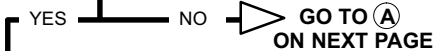

IS UNIT IN COOLING MODE?
REVERSING VALVE SHOULD BE ENERGIZED.
REVERSING VALVE ENERGIZED/



CHECK VOLTAGE ACROSS TERMINALS R AND X AT UNIT LOW VOLTAGE TERMINAL STRIP TB15. IS VOLTAGE 24±6VAC?

- | | |
|---|--|
| <p>YES</p> <p>CHECK REVERSING VALVE FOR MALFUNCTIONS. REPLACE IF NECESSARY.</p> | <p>NO</p> <p>CHECK INDOOR THERMOSTAT FOR MALFUNCTIONS. REPLACE IF NECESSARY.</p> |
|---|--|

REPEAT TROUBLESHOOTING PROCEDURE.

HIGH SPEED COOLING O.K.

LOW SPEED COOLING

- 1- TURN INDOOR THERMOSTAT TO OFF POSITION.
- 2- DISCONNECT THERMOSTAT WIRE FROM TERMINAL Y2 OF HEAT PUMP LOW VOLTAGE TERMINAL STRIP TB15.
- 3- SET INDOOR THERMOSTAT TO LOWEST TEMPERATURE SETTING.
- 4- TURN INDOOR THERMOSTAT TO COOL MODE.
- 5- IF POWER TO OUTDOOR UNIT HAS BEEN OFF, WAIT AT LEAST 10 SECONDS TO ALLOW TSC TO POWER-UP.
- 6- PUSH AND RELEASE THE OVERRIDE BUTTON ON THE TSC TO BY-PASS THE 5-MINUTE TIMED-OFF DELAY.
- 7- ALLOW 1 MINUTE FOR THE UNIT TO START.

DOES UNIT START AND RUN ON LOW SPEED?

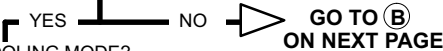

IS UNIT IN COOLING MODE?
REVERSING VALVE SHOULD BE ENERGIZED.
REVERSING VALVE ENERGIZED/



LOW SPEED COOLING O.K.

**TSC OPERATING PROPERLY.
REASSEMBLE UNIT.**

HIGH SPEED HEATING

- 1- TURN INDOOR THERMOSTAT TO OFF POSITION.
- 2- PLACE A JUMPER WIRE ACROSS SPEED CONTROL THERMOSTAT S55 IN OUTDOOR UNIT.
- 3- SET INDOOR THERMOSTAT TO HIGHEST TEMPERATURE SETTING.
- 4- TURN INDOOR THERMOSTAT TO HEAT MODE.
- 5- IF POWER TO OUTDOOR UNIT HAS BEEN OFF, WAIT AT LEAST 10 SECONDS TO ALLOW TSC TO POWER-UP.
- 6- PUSH AND RELEASE THE OVERRIDE BUTTON ON THE TSC TO BY-PASS THE 5-MINUTE TIMED-OFF DELAY.
- 7- ALLOW 1 MINUTE FOR THE UNIT TO START.

DOES UNIT START AND RUN ON HIGH SPEED IN HEATING MODE?

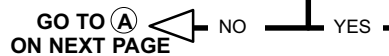

HIGH SPEED HEATING O.K.

LOW SPEED HEATING

- 1- TURN INDOOR THERMOSTAT TO OFF POSITION.
- 2- REMOVE THE JUMPER WIRE FROM ACROSS SPEED CONTROL THERMOSTAT S55 IN OUTDOOR UNIT.
- 3- DISCONNECT THE FACTORY WIRING FROM EITHER SIDE OF SPEED CONTROL THERMOSTAT S55.
- 4- SET INDOOR THERMOSTAT TO HIGHEST TEMPERATURE SETTING.
- 5- TURN INDOOR THERMOSTAT TO HEAT MODE.
- 6- IF POWER TO OUTDOOR UNIT HAS BEEN OFF, WAIT AT LEAST 10 SECONDS TO ALLOW TSC TO POWER-UP.
- 7- PUSH AND RELEASE THE OVERRIDE BUTTON ON THE TSC TO BY-PASS THE 5-MINUTE TIMED-OFF DELAY.
- 8- ALLOW 1 MINUTE FOR THE UNIT TO START.

DOES UNIT START AND RUN ON LOW SPEED IN HEATING MODE?

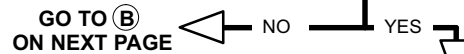

LOW SPEED HEATING O.K.

**TSC OPERATING PROPERLY.
REASSEMBLE UNIT.**

CHECK VOLTAGE ACROSS TERMINALS O AND X AT UNIT LOW VOLTAGE TERMINAL STRIP TB15. IS VOLTAGE 24±6VAC?

- | | |
|---|--|
| <p>YES</p> <p>CHECK REVERSING VALVE FOR MALFUNCTIONS. REPLACE IF NECESSARY.</p> | <p>NO</p> <p>CHECK INDOOR THERMOSTAT FOR MALFUNCTIONS. REPLACE IF NECESSARY.</p> |
|---|--|

REPEAT TROUBLESHOOTING PROCEDURE.

TABLE 20b

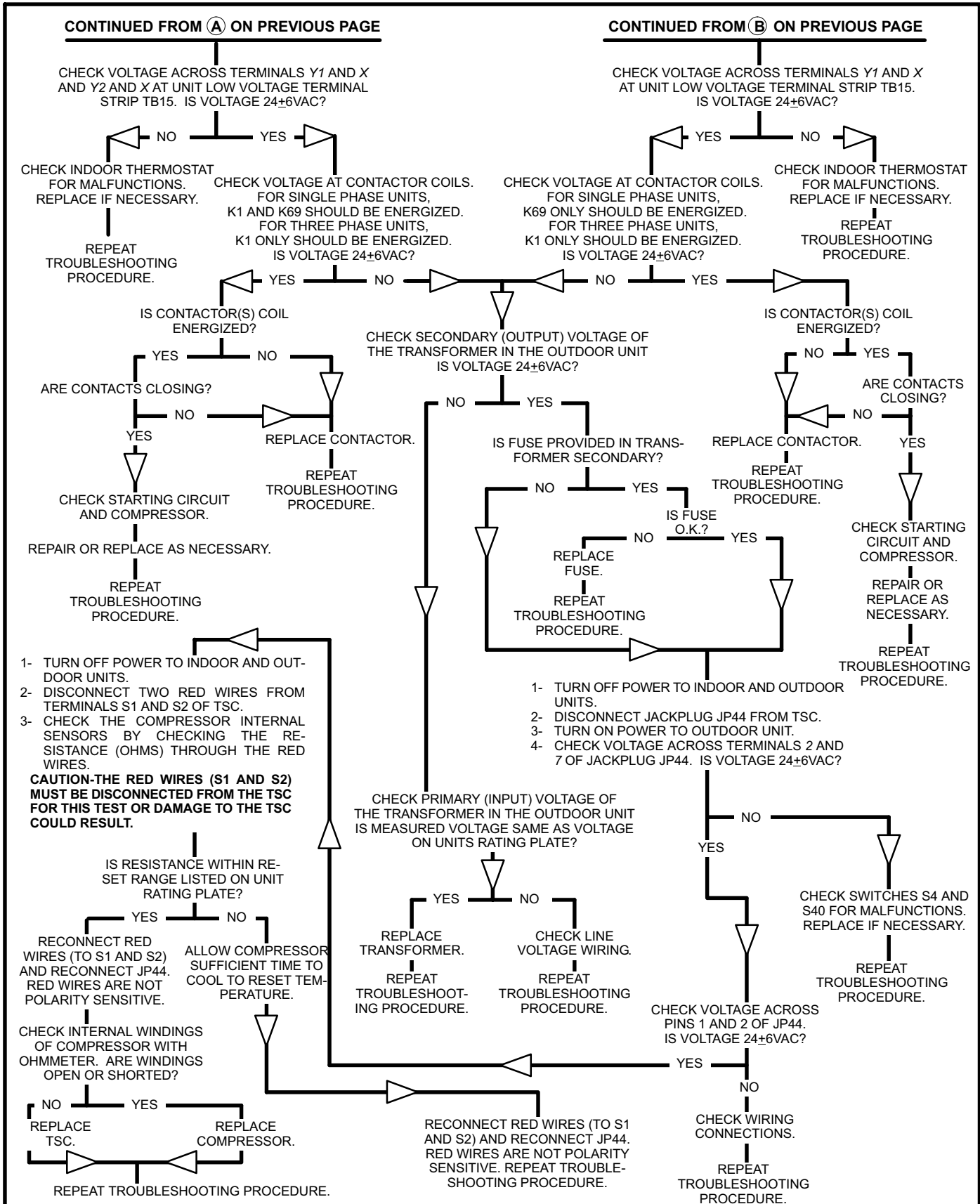

SERVICE NOTES